

THE NEXT GENERATION SPACE TELESCOPE

Visiting a Time When Galaxies Were Young

The NGST Study Team

Edited by H.S. STOCKMAN

Space Telescope Science Institute

June 1997

©1997

The Association of Universities
for Research in Astronomy, Inc.

All rights Reserved.

Contents

Preface and Acknowledgments	i
Authorship	iii
Executive Summary	v

1	
Studying the Early Universe: The Dark Ages	1
2	
Seeing Beyond the Hubble Space Telescope	17
3	
The NGST Challenge: Establishing Feasibility	34
4	
Concepts for the Next Generation Space Telescope	45
5	
Launch and Orbit	53
6	
Large Space Telescopes: An Issue of Transportation	62
7	
The Science Instrument Module: Recording the Light from Stars and Galaxies	82
8	
The NGST Spacecraft Support Module	97
9	
Operating and Using NGST	109
10	
Technology for the Next Generation Space Telescope	121

Appendices

A	
Contributors to the NGST Study	136
B	
References and Suggested Reading	143
C	
The Design Reference Mission	146
D	
The NGST- δ Concept	154
Acronyms	157

Preface and Acknowledgments

In the spring and summer of 1996, three independent teams studied the feasibility of a large aperture space telescope to follow the Hubble Space Telescope. The scientific goals for the new telescope had been laid out in a report by the HST & Beyond Committee, a group appointed by the Association of Universities for Research in Astronomy to consider the needs of the astronomical community after the nominal end of the HST mission in 2005. The technical capabilities and constraints on the new observatory were daunting: the telescope optics should be at least 4 meters in diameter and passively cooled to achieve optimum sensitivity in the near-infrared portion of the spectrum. Moreover, the costs should be kept within a fraction of those for the HST: approximately \$500M for construction and \$900M for lifetime costs, not including support for scientific data analysis.

In their presentations to NASA on 19-21 August, 1996, the teams led by Lockheed Martin, TRW, and the Goddard Space Flight Center concluded that a Next Generation Space Telescope (NGST) was not only feasible and affordable, but that it could be made more powerful using recent breakthroughs in space technologies. Coming on the heels of breathtaking HST observations of distant galaxies in the process of formation, such an NGST could bridge the gap in our understanding of the earliest origins of stars, galaxies, and the elements that are the foundations of Life. This report presents the findings of the three teams and the technological roadmap which will guide us to the successful development of the NGST over the next decade.

We have made liberal use of the written material, tables, and diagrams prepared by the three study teams. We have also taken advantage of the knowledge and ideas of our colleagues in government, industry and academia. In Appendix A, we list the members of the three study groups, the NGST Science Working Group and the NGST Scientific Oversight Committee. We deeply appreciate their assistance, advice, and enthusiasm.

The scientific and technological goals of NGST are part of the Origins initiative in the Office of Space Science, NASA Headquarters. We are

pleased to acknowledge the support and leadership of Edward Weiler, a steadfast friend of HST, Harley Thronson, a proponent of all things infrared, and Mike Kaplan, a tireless advocate of new technology. John Campbell, Project Manager for HST, initiated the NGST study at GSFC and we deeply appreciate his formative efforts and continued support. We are also grateful for the foresight of Riccardo Giacconi, Director General of the European Southern Observatory (ESO), and the efforts of his staff. We note that European Space Agency (ESA) staff at the Space Telescope Science Institute and ESO played important roles in the NGST scientific and technical studies. We look forward to future collaboration with ESA, ESO, and other international partners.

Authorship

THIS REPORT summarizes the contributions from the hundreds of individuals and dozens of institutions listed in Appendix A. We are pleased to acknowledge the useful comments and suggestions received from colleagues and, in particular, the members of the Scientific Oversight Committee.

Editor

H. S. (Peter) Stockman, Jr.
Space Telescope Science Institute

Contributing Editors

Pierre Bely
Space Telescope Science Institute

Dan Coulter
Jet Propulsion Laboratory

Keith Kalinowski
Goddard Space Flight Center

Mike Krim
Hughes Danbury Optical Systems

Charles Lillie
TRW Corporation

Michael Margulis
Lockheed Martin Missiles and Space Company

John Mather
Goddard Space Flight Center

Michael Mesarch
Goddard Space Flight Center

Lloyd Purves
Goddard Space Flight Center

Bernie Seery
Goddard Space Flight Center

Patricia Pengra, *Managing Editor*
Space Telescope Science Institute

Lori Keesey, *Assistant Editor*
Keesey & Associates

Executive Summary

SEARCHING FOR THE ORIGIN of the universe is very much like archeology. Astronomers, like archeologists, must peel away the strata of time to find clues. Over the past few decades, astronomers have made great progress doing just that — peering farther and farther back in space and time to study objects that existed when our universe was still very young.

Astronomers have uncovered tantalizing clues in images taken by the Hubble Space Telescope (HST). In one image (Hubble Deep Field, below, and detail at top of next page), they found a myriad of galaxies that formed perhaps 5 billion years after the Big Bang. Surprisingly, the fledgling galaxies seem very well-developed and exhibit many of the features of current galaxies. From this, astronomers have deduced that the galaxies formed much earlier — perhaps only a few billion years after the cataclysmic explosion that gave birth to the universe.

The Hubble Deep Field. Several hundred never-before-seen galaxies are visible in this “deepest-ever” view of the universe, made with NASA’s Hubble Space Telescope. Besides the classical spiral and elliptical shaped galaxies, there is a bewildering variety of other galaxy shapes and colors that are important clues to understanding the evolution of the universe.



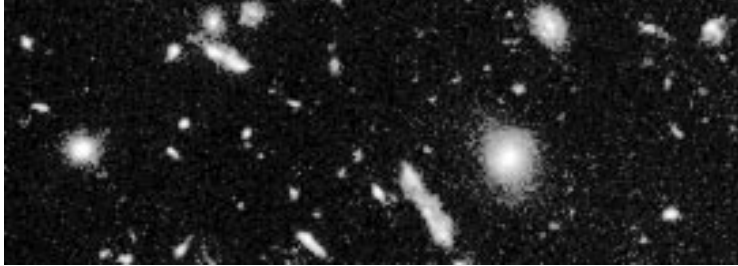

Hubble Deep Field (detail). This detail shows distant spirals and spherical galaxies as well as blue, disturbed galaxies that are presumably large star forming regions, perhaps within a larger undetected host galaxy.

COBE reveals the Beginning of Structure. This Cosmic Background Explorer (COBE) false-color map of the sky shows tiny differences in the density of matter in the universe soon after the Big Bang. High-density regions (blue) are believed to have evolved into the largest scale structure seen in the universe today.

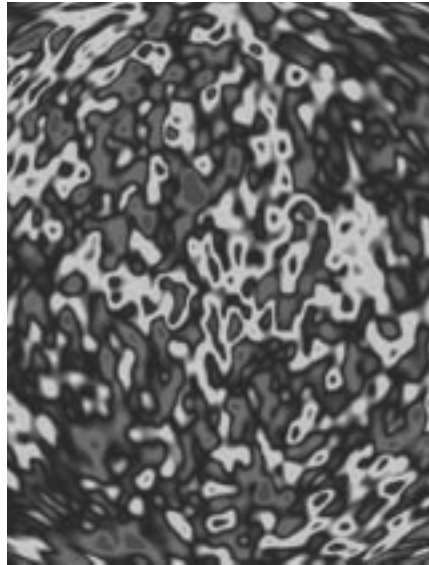

Astronomers also have uncovered clues in data gathered by the Cosmic Background Explorer (COBE) (above, right). The explorer-class observatory detected the seeds of galaxies and other large-scale structures that began to evolve just 300,000 years after the Big Bang. How did these seeds condense into the stars and galaxies observed by Hubble? This period of time might be called the “dark zone” — a gap in the history of our universe that holds the secrets of its evolution.

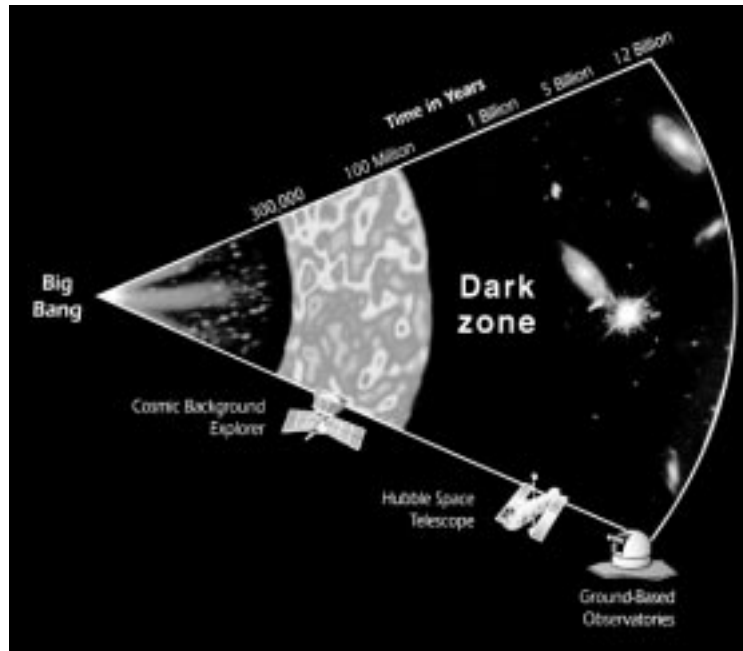

Visiting a Time When Galaxies Were Young. NGST will observe the “dark zone,” a period when primordial seeds began to evolve into the galaxies and stars we see today.

The Answer

To see the first generations of stars, the science community believes it will need a successor to Hubble. Even with new instruments, Hubble’s observations are limited to “adolescent” objects. The younger objects, which are receding from us at an even faster rate, are redshifted into the near infrared (past 2 microns) where Hubble loses sensitivity. Known as the Next Generation Space Telescope (NGST), the observatory will be sensitive to infrared radiation and, with its large light-gathering mirror and superb resolution, capable of detecting faint signals from the first billion years — the period when galaxies formed (above).

For such observations, the new telescope will be chilled to the low temperatures of outer space and placed in an orbit beyond the

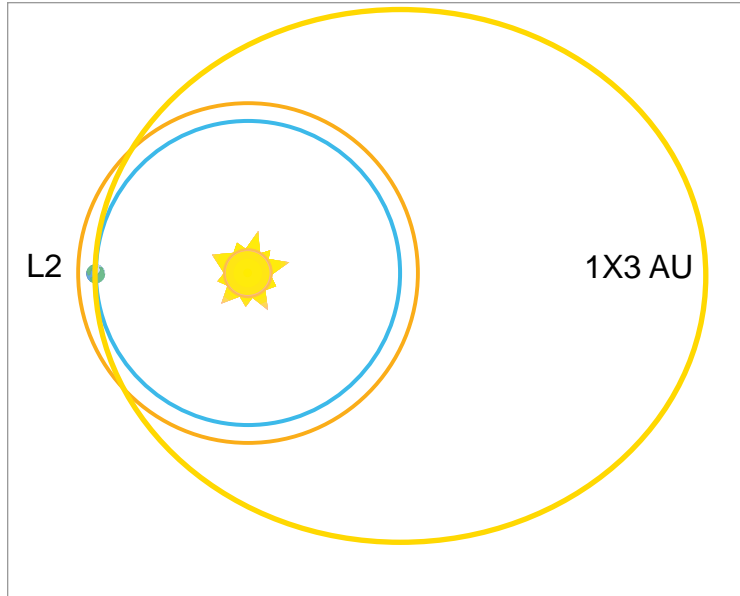

NGST Orbit. To enhance its performance, scientists hope to place the observatory as far from the Earth-Moon system as possible to reduce stray light and to maintain the telescope's relatively cool temperature. Two orbits being considered are the second Lagrange point (L2) and a 1 x 3 AU solar orbit.

Moon (above). The location and low temperatures make the observatory thousands of times more sensitive than Earth-bound telescopes, and enables astronomers to see how and when the first generations of stars appeared and how quickly those stars manufactured the heavy elements that eventually became the material for worlds like Earth.

With such a capability, astronomers will finally lift the veil that now obscures the dark zone of the universe's first billion years.

"HST and Beyond" Report

Today, astronomers have at their disposal a variety of ground- and space-borne telescopes and instruments, operating at a wide range of wavelengths. Given the variety, and the intense competition for funding, the science community is mindful that a solid scientific case is needed to support a follow-on mission to the enormously successful Hubble Space Telescope.

In its report, "HST and Beyond," the blue ribbon committee appoint-

ed by the Association of Universities for Research in Astronomy (AURA) recommended such a follow-on mission. The report urged the development of a general-purpose, near-infrared observatory equipped with a primary mirror larger than 4 meters. Able to maintain a cool temperature of 70 K or lower, the observatory would be up to 1,000 times more sensitive than any existing or planned facility in the 1-5 micron region. To further enhance its performance, the report recommended that the observatory be placed as far from the Earth-Moon system as possible to reduce stray light and to maintain the telescope's relatively cool temperature.

With such capability, the panel concluded that future generations of astronomers could learn in detail how galaxies formed. They could determine the shape of the very early universe by measuring standard candles such as supernovae. They could trace the chemical evolution of galaxies as stars released their material back into space. And they could study nearby stars and star-forming regions for signs of planetary systems such as our own. This facility would be a major step toward answering one of the most profound questions known to humankind: Are we alone in the universe?

Feasibility Studies

For the science community, the issue of whether to pursue a follow-on mission is not one of need, but rather one of technical and financial feasibility. The question becomes: Can NASA build a technically challenging next-generation space telescope in an era of reduced funding?

With support from NASA Headquarters, the Goddard Space Flight Center and the Space Telescope Science Institute led a team made up of other NASA field centers and engineering firms to study whether NASA could realize that vision. To make sure it gathered the best ideas that academia and industry could offer, the agency funded two independent studies by consortia led by Lockheed Martin and TRW.

All three teams found that NASA could launch NGST by 2005. They also confirmed that because of advanced technology and the requirement that the observatory have one-fourth the mass of Hubble, the agency would be able to build NGST for significantly less than the \$2 billion (1990 dollars) it had invested in Hubble. Each of the studies assumed, however, that NASA would receive at least \$175 million (1996 dollars) for mission definition and technology development and another \$500 million for construction.

The Concepts

Although the study teams believe NGST is feasible with the development of certain technologies, they also understand that the program faces many challenges. As the feasibility studies point out, NGST will require a very different design from any observatory flown before. NGST will fly a significantly larger mirror, even though the observatory itself will be much less massive — especially compared with the Hubble Space Telescope's schoolbus-sized dimensions.

The study teams based their analyses on the following criteria: First, the telescope should operate far from Earth to maintain its cool temperature. Second, it should be lightweight and compact so that a mid-sized launch vehicle, such as the Atlas IIAS, could carry it into space. (The Atlas IIAS, for example, can for about \$100 million transport 2800 kg to the Lagrange point L2 — one of the orbits under consideration.) And third, the telescope's mirror should be adjustable in flight to correct for deployment misalignments and thermal effects.

NASA and its industry and academic partners studied three approaches (below):

- Deployable 8 m segmented primary mirror telescope and erectable sunshield, deployed at L2 (TRW).
- Monolithic 6 m thin shell primary mirror telescope and fixed sun shade, in an interplanetary orbit beyond that of Mars (Lockheed Martin).

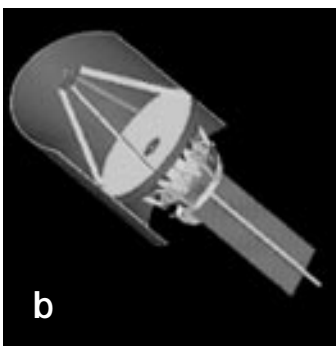
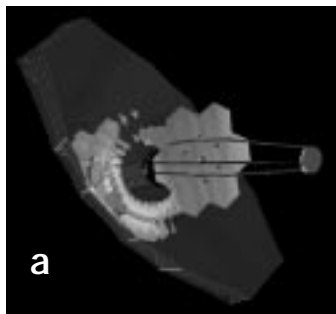

(a) TRW model; (b) Lockheed Martin model; (c) Goddard model.

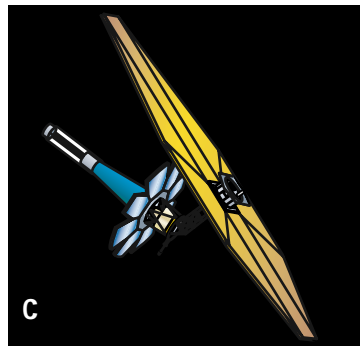

- Deployable 8 m segmented primary mirror telescope and inflatable sunshield, deployed at L2 (GSFC).

All three concepts share certain design features, including adjustable thin mirrors, deep space orbits, fast-steering mirrors for fine guidance, infrequent contact with the ground and a mass of about 2800 kg. They differ in the areas of mirror construction, materials and deployment, detector types, sunshield types, vibration control and launch vehicles.

Technology Readiness

The most important and difficult part of the mission is designing and building the primary mirror (below). While the mirror would be the largest ever flown on a space-borne observatory, it would have to remain relatively lightweight to meet the mass requirements. Despite these challenges, the study teams studied several approaches that would work. In short, the main conceptual breakthroughs needed to carry out NGST are available today.

The University of Arizona, which was part of the Lockheed Martin team that studied the 6 m monolithic mirror, has already demonstrated a sample mirror that meets NGST's weight and accuracy requirements. The necessary sensor and computer algorithms to control such a mirror are already used at ground-based observatories, as well.

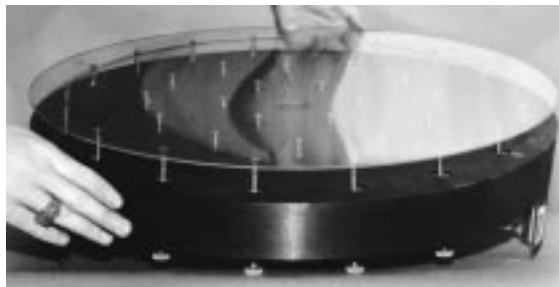

NGST Mirror. This prototype is the first ultralightweight mirror made using MARS technology — Membrane with Active Rigid Support. The 0.5 m diameter mirror combines a 2 mm thick Zerodur membrane and 36 piezo-driven screw actuators for on-orbit wavefront control with a carbon fiber support for a total mass of 5 kg. (Lockheed, University of Arizona)

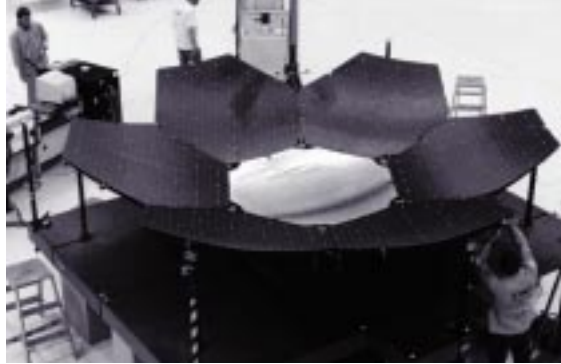

Precision Deployable Structure Prototype. A 4.5 m diameter reflector constructed for the TRW High Accuracy Reflector Development program (HARD). Composed of seven, 2 m hexagonal panels, the deployed reflector has been successfully tested for use at 60 GHz. It has been qualified for missions launched on the Shuttle or a Titan IV. (TRW)

It also appears possible to deploy a segmented primary mirror and adjust it to the correct figure after launch — the approach suggested by the GSFC and TRW teams. With this design, NASA could build an 8 m mirror which would fold down to fit inside the Atlas IIAS 4 m launch shroud. Making the concept even more attractive is the fact that TRW built a space-qualified deployment mechanism around 1987 for a 60 GHz antenna with a 4.6 m aperture (above).

The other advances needed for the NGST are within reach, too. Improved infrared detectors are as important as improved telescope efficiency and collecting area. NASA's SIRTf mission has demonstrated detectors that are close to meeting the NGST sensitivity requirements.

Further Study Required

Further study is required before NASA and the scientific community can recommend a particular approach. The program is still in the early stages. In addition to unresolved technology questions, the question of how to transport the observatory to orbit remains unresolved. Mission planners need to know the cost and shroud sizes of launch vehicles that will be available less than a decade from now. The availability of a large, yet affordable rocket might make a non-deployable telescope more attractive. However, scientists and engineers also could argue that a deployable telescope would give mission planners experience build-

ing the ultimate system — one that could image an Earth-sized planet around another star.

In other words, NASA's strategic plan is as significant a factor as cost and astronomical performance.

In the meantime, the NGST Science Team has developed a Design Reference Mission (DRM), representing the core scientific program and a broad range of astronomical observations. It will be used to judge the capabilities of various telescope configurations and to compare aperture benefits and costs with operations costs. Eventually, after extensive scientific and technical debate, the DRM will be refined to be the key tool used in selecting a prime contractor, choosing a design concept and paying contractor incentive award fees.

Reasons for Optimism

Breaking the Hubble cost paradigm has happened. Since the Hubble program began two decades ago, the space industry has evolved considerably. Aerospace companies now offer standard, off-the-shelf commercial products for spacecraft design. These range from relatively low-cost spacecraft electronics to launch vehicles. The industry also has benefited from the revolution in computer technology. With paperless simulation-based design, engineers can run elaborate computer simulations to test design concepts before investing valuable resources in their construction.

The military's investment in space technology also will keep down the observatory's development costs. Its investment in detector technology, for example, has resulted in the development of large infrared array detectors, which are as sensitive as the CCDs used at shorter wavelengths. Furthermore, Lockheed Martin is building the SIRTf spacecraft and has found ways to cut spacecraft bus and integration costs by using radiative cooling. In short, much that seemed impossible just a few years ago is now feasible and affordable.

We can expect the NGST to prosper from these innovations. Instead of building a proprietary system, equipped with custom technology, the next generation observatory will use much of what is already available, bringing down development costs and the time needed to design, build and fly it.

Conclusion

Clearly the NGST is an ambitious program. It demands conceptual breakthroughs, technology refinements and a demonstration of its reliability as evidenced by the NASA and contractor team studies. The competing requirements of "better" and "cheaper" add additional challenges. Although we have not yet reached a point where we can select a specific design approach, it is clear that new concepts and technology will allow us to

build NGST for a small fraction of Hubble's cost. Our path to reach this goal will be made of equal steps — thinking, building, and testing.

What must be stressed is that the observatory's proposed capabilities will far exceed anything possible from the ground or in space — at least in the foreseeable future. No other mission offers NGST's combination of large aperture, low temperature and ideal observing environment. The observatory will allow astronomers to study the first protogalaxies, the first star clusters as they make their first generation of stars, and the first supernovae as they release heavy chemical elements into the interstellar gas. With its exceptional sensitivity and wide fields of view, it will let scientists study a range of topics, everything from interstellar chemistry to brown dwarf stars to potential planets around nearby stars.

What we might learn by flying a Next Generation Space Telescope capable of observing the early universe and objects relatively closer to home is incalculable. Though we can plan, we cannot definitely predict the outcome. History has shown that many of the world's most profound discoveries happen by accident. Our objective now is to prepare for the next generation of discovery, to develop key technologies and fine tune the science requirements. These studies represent a start in the process, a process that is vital if we want the unprecedented era of astronomical discovery begun in the 20th century to continue well into the 21st.

CHAPTER 1

Studying the Early Universe: The Dark Ages

The Golden Age of Astronomy

THIS CENTURY has brought about an explosive period of growth and discovery for the physical sciences as a whole, and astronomy in particular. Astronomers enjoy unprecedented public support, advances in technology and major discoveries in fundamental physics — conditions that allow us to reach far beyond our solar system to observe and contemplate the richness of the universe on unthinkable scales. In this century, we discovered how stars live and die; we proved that our solar system and our galaxy are not alone in the universe; we found that our universe is expanding and had a beginning and, perhaps, an end; and we discovered how the elements — the building blocks of life itself — originated in the primeval fireball, the internal furnaces of stars and the nuclear explosions that accompany star death. Perhaps most astoundingly, we can view the edge of the universe at radio wavelengths, seeing the mist of hot plasma out of which stars and galaxies grew to create our tiny home.

In the second half of this century, space instruments have played crucial roles in these discoveries. Satellites and attached payloads flown during manned space missions gave us the ability to see wavelength bands never before seen from Earth. Our eyes were opened to Gamma rays, X-rays, ultraviolet (UV), and the far-infrared regions of the electromagnetic spectrum. Space-based observatories even enhanced our ability to see objects in visible light by extending our eyes above Earth's turbulent and obscuring atmosphere. Sensitive to UV, visible and near-infrared (NIR) light, the Hubble Space Telescope (HST) provides a case in point. Operating 380 miles above Earth's surface, HST regularly delivers images of the universe at breathtaking resolution and contrast. HST and the Compton Gamma Ray Observatory (CGRO) are the first two of four missions in the NASA Great Observatories. By 1998 and 2001, HST and CGRO will be joined

respectively by the Advanced X-ray Astrophysics Facility (AXAF) and the Space InfraRed Telescope Facility (SIRTF). These facilities, like HST and CGRO, are designed to provide another leap in sensitivity in the X-ray and infrared (IR) spectral regions.

The Great Observatories take their place in an armada of ground and space facilities currently in operation, in construction, or in early planning phases. New facilities require many years of analysis and study before winning approval. Therefore, the scientific community and funding agencies, such as the National Aeronautics and Space Administration (NASA) and the National Science Foundation (NSF), must conduct critical long-range planning. In this context, the Association of Universities for Research in Astronomy (AURA), with NASA support, appointed a committee of leading research astronomers to “study possible missions and programs for UV-Optical-IR astronomy in space for the first decades of the twenty-first century.” Led by Alan Dressler, the HST and Beyond Committee gathered recommendations from members of the American Astronomical Society and the international astronomy community. Through preliminary reports and public meetings, the committee arrived at two major scientific goals to propel the field of astronomy into the next decade: The detailed study of the birth and evolution of normal galaxies such as our Milky Way; and the detection of Earth-like planets around other stars and the search for evidence of life on them. In its final report, *Exploration and the Search for Origins: A Vision for Ultraviolet-Optical-Infrared Space Astronomy*, the HST and Beyond Committee described these goals and made the following three recommendations to AURA and NASA:

- 1) “The HST should be operated beyond its currently scheduled termination date of 2005.” The committee feels that HST provides a capability for ultraviolet studies and wide-field optical imaging whose loss would be strongly and widely felt.
- 2) “NASA should develop a space observatory of aperture 4 m or larger, optimized for imaging and spectroscopy over the wavelength range 1–5 μm .” Such an observatory would be a unique and essential tool in many areas of astronomy and essential for the study of the birth of normal galaxies.
- 3) “NASA should develop the capability of space interferometry.” Such a capability will have long-range consequences for the advancement of astronomy in space and offers the only way to discover and study potential life-bearing planets around nearby stars.

These recommendations and those from the Space Interferometry Science Working Group (SISWG) and the Exploration of Neighboring Planetary Systems (ExNPS) Study Team greatly influenced NASA’s

plans for the next decade. The search for and understanding of the origins of our galaxy, our solar system and life itself became one of the four major themes for future NASA missions. In the last year, the Jet Propulsion Laboratory (JPL/NASA) initiated the design of the first space interferometer, the Space Interferometry Mission (SIM). Goddard Space Flight Center (GSFC) also began a feasibility study of the large, passively cooled telescope envisioned by the HST and Beyond Committee. This telescope is called the Next Generation Space Telescope (NGST). This report summarizes the scientific and engineering results of the NGST study. In this chapter, we build on the strong scientific recommendations of the HST and Beyond Committee to develop the framework for the technical studies that follow.

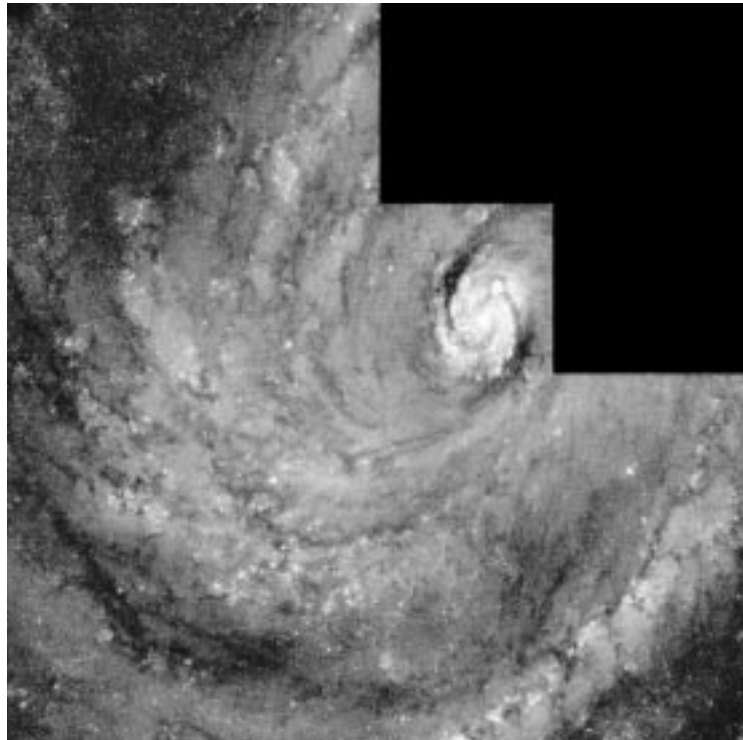

FIGURE 1.1. A nearby grand spiral galaxy — where we live. An HST/WFPC2 three-color image of the spiral galaxy M100 in the Virgo cluster of galaxies. The dark lanes that marble the disk are regions obscured by thick dust clouds, the sites of future star formation. (NASA/STScI)

The Origins of Galaxies

The Milky Way galaxy is home to our solar system and, presumably, billions like it. Our Galaxy is not simply a pinwheel of stars circling a common center. Rather it is a dense bulge of old, established stars and a disk of gas and stars that give birth to new stars and planetary systems. An ancient, thin halo of old stars and dense groups of stars, known as globular clusters, circle the galaxy. These are the relics of the early formation of the galaxy and the results of encounters with smaller galaxies over many billions of years. The cycling of gas into massive, cold molecular clouds and hence into stars never ends. Spiral waves of gas clouds and stars complete their circuit of the Galaxy every 200 million years, creating star-forming conditions. In turn, aging stars die and spew their gas — laden with newly formed elements, such as carbon, oxygen, nitrogen and silicon — into the Galaxy. With each cycle, the Galaxy becomes more enriched with metals and stars whose lifetimes are comparable to the age of the universe. Perhaps some of these old, unobserved small stars provide the gravitational glue that holds the Galaxy together. More likely, the Galaxy also holds a massive reservoir of dark matter that only interacts with the stars and gas through its gravitational field.

What will be the ultimate fate of our Galaxy? Is it still growing? More important, how did such a massive structure of more than one hundred billion (10^{11}) suns form from the smooth, almost perfectly uniform hot gas that filled the universe soon after the Big Bang? Astronomers have tried to answer these questions by studying the spectral signatures of many thousands of stars in the Galaxy to determine their age and metal content. But reconstructing the birth of the Galaxy with such bones is hard and ultimately uncertain work. Too many processes could leave the same evidence. Some young galaxies in our neighborhood are still forming as small, irregular structures of gas and stars. Although they are many millions of parsecs away (1 parsec = 3.26 light-years), astronomers study them using HST and the modern generation of ground-based telescopes. However, the conditions of their formation are different from those of our own galaxy. Their gas is full of metals (astronomers' name for all elements heavier than helium), spewed out from distant galaxies and mixed over many billions of years. Astronomers have long dreamed of studying our galactic origins by observing very distant galaxies that formed when our own galaxy formed. That dream is rapidly becoming a reality. *HST has shown that by observing the faint light emitted by stars many billions of years ago, we can look back in history to a time when galaxies were young.*

The universe is remarkably empty and clear. In 1995, the HST observed a small region of the sky for more than a week to make the

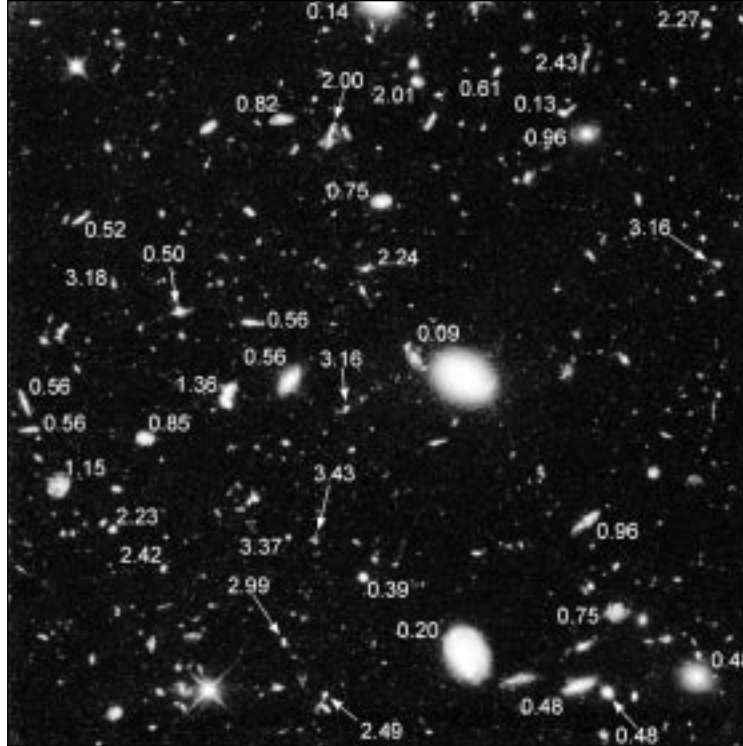

FIGURE 1.2. The Hubble Deep Field. An 80" x 80" portion of the true color image obtained from 342 separate exposures taken during 10 days in Dec. 1995. Blue objects contain young stars and are relatively close. Red objects may be old stars or very distant galaxies, whose blue light has been redshifted or absorbed by intergalactic hydrogen. The numbers refer to the measured redshift of the adjacent galaxy. (NASA/STScI, redshifts from Keck 10 m + Low Resolution Imaging Spectrograph)

deepest optical image ever taken of the universe. In the Hubble Deep Field (HDF, Figure 1.2), we find more than 2,000 galaxies and only a dozen or so faint stars. Because astronomers deliberately chose this field to avoid bright galaxies and stars, most of the galaxies are very distant. We can estimate the distance to these objects by observing the Doppler shift in their spectral features and ascribing it to the overall expansion of the universe. The change in the observed wavelength, $\lambda_{\text{observed}} - \lambda_{\text{rest}} = z\lambda_{\text{rest}}$, is related to the distance by the Hubble law which states that distance increases almost proportionally with z , the "redshift." (The value that relates distance and recessional velocity and redshift is the Hubble constant, H_0). Even the brighter spirals in the HDF image have redshifts of $z = 0.1$ and distances of 3×10^8 parsecs or

almost a billion light-years. For higher redshifts, the relationship between redshift and the apparent (luminosity) distance depends on the cosmology, the expansion history and geometry of the universe. The most distant objects identified in the field are approximately 10 billion light-years away, and appear to be receding at 94–97% the speed of light, according to their redshifts of $z = 2$ –3. Some of these “galaxies” appear bizarre compared with those we see about us. We are viewing them in their ultraviolet light, the light of hot, young massive stars which is Doppler-shifted into our visible band.

The universe was different then, more crowded and more dense. To understand these galaxies, their structures, and their internal motions or dynamics, we must capture the light of their established star populations in our infrared (IR) spectral regions. For example, we would observe a galaxy at a redshift of $z = 2$ which emits most of its starlight in the visible to near-IR ($\lambda = 0.5$ – $1.0 \mu\text{m}$) in our near-IR bands ($\lambda = 1.5$ – $3.0 \mu\text{m}$). Moreover, the key CO absorption lines at $2.3 \mu\text{m}$ would appear at 6.9 mm . The detailed study of the universe at redshifts $z = 1$ –3 is part of the reason for the HST and Beyond Committee’s recommendation for an NGST. The other part involves observing the very start of star and galaxy formation early in the life of the universe, at even higher redshift.

Galaxy Evolution after the Big Bang

One of the great triumphs of 20th century science was the detection of the microwave background, the redshifted radiation of the primeval fireball. The Cosmic Background Explorer (COBE) revealed that the microwave background has remained essentially unaltered since it escaped from the expanding hot gas at a redshift of $z \sim 1300$ (approximately 300,000 years after the universe began). It is also remarkably smooth, with brightness deviations of only 0.001% on angular scales of 7° , corresponding to structures today of 100 Mpc. These temperature differences correspond to similarly small fluctuations in density, imprinted on the universe in the instant of formation. According to most theories of galaxy formation, the gravitational merging of these and smaller-scale fluctuations created the hierarchical structures that we observe today: galaxies, groups of galaxies, clusters of galaxies and giant sheets and voids. Future space missions, such as the Microwave Anisotropy Probe (MAP) and the European Space Agency (ESA) mission, Planck Surveyor, will measure the microwave deviations on scales of 10–20’ (minutes of arc). We expect to match the results to various models of the early universe and independently deduce the fundamental parameters of the Big Bang and the geometry of the universe (the

total mass density Ω_0 , H_0 , and the properties of dark matter). However, the growth of stars, galaxies and groups of galaxies is the result of processes more complex than simple gravity. Large-scale computer models of the early days of star and galaxy formation must include gas pressures, various radiative cooling and heating processes and a model for actual star formation. Today we can model galaxy formation with mass scales down to $10^8 M_{\text{solar}}$, barely small enough to represent a large star-formation region. While our computational abilities will continue to improve, we will gain confidence in such models only when we can



FIGURE 1.3. Simulated NGST image for an open universe $\Omega_0 = 0.35$ and $H_0 = 75$. The numbers refer to the redshifts of the adjacent galaxies. Elliptical galaxies are formed via major merging. Star formation in disks and irregulars begins after $z = 3$. At high redshift ($z > 5$), the model uses the theory of Haiman and Loeb (1997) to estimate the number of collapsed, star forming protogalaxies. With a 10 hr exposure, NGST could detect 100 objects at redshifts greater than $x > 5$ in this small portion (1%) of the entire NGST field of view. The object with $z = 12.46$ (center left) has an apparent magnitude of $K_{AB} = 29.8$. (Myungshin Im/ST ScI)

compare them with actual observations.

Many astronomers believe that the first stars and structures formed in the redshift range $z = 5\text{--}30$. Deep images, such as the HDF, and the existence of bright AGN at redshifts $z \sim 5$ are inconsistent with more recent structure formation. Little time remains for star formation, to say nothing of galaxy formation, at redshifts much higher than $z = 30$. This period is shown schematically in the executive summary figure, relative to the current age of the universe, $z \sim 0$, and the epoch of radiation and matter decoupling, the COBE mist at $z \sim 1300$. Most astronomers favor the slow, bottoms-up formation of galaxies during the $z = 5\text{--}30$ period. In this picture, many small structures form first, perhaps the origins of the ancient globular clusters that circle our Milky Way. These are actually the tips of much larger icebergs of dark matter that continue to grow through mergers and the accretion of gas. We can test these theories by observing early galaxies and their dynamics. The best approach for detecting these early structures is to observe them during periods of significant star formation. During the first five million years of their life, the rare, short-lived massive stars far outshine in the ultraviolet their more numerous and less massive companions. In their death throes, they become red supergiants that radiate intensely in the near-IR (NIR). As shown in Chapter 2, the most sensitive region for space imaging is in the $1\text{--}4\ \mu\text{m}$ band. For a sufficiently bright early galaxy, we can expect to detect its ultraviolet radiation ($\lambda = 0.12\text{--}0.2\ \mu\text{m}$) in this NIR band for redshifts of $5 < z < 30$, or precisely the most likely redshift range for early galaxy formation.

Different theories of galaxy formation predict different views of the heavens. But all successful theories must yield the same number and sizes of galaxies seen in the HDF and the deepest NIR images taken from mountaintop observatories. As an example, we simulated a possible NGST image for a specific cosmology using a model of galaxy formation that assumes that galaxies grow by star-formation and merging. We adjusted the final number and types of galaxies to match the number and colors of galaxies observed with HST and ground telescopes. We cannot yet determine whether the cosmology and galaxy formation model are correct with today's telescopes. With NGST, however, we should be able to tell easily. In Figure 1.3, we show a small part of the NGST field-of-view in three NIR colors: blue corresponds to the "I" color band ($\lambda = 0.8\ \mu\text{m}$), green corresponds to the "J" color band ($\lambda = 1.2\ \mu\text{m}$), and red corresponds to the "K" band ($\lambda = 2.2\ \mu\text{m}$). Since the model must yield the correct number of bright galaxies seen today, the number, sizes, and colors of the fainter galaxies will indicate whether we are on the right track. The model that we have chosen assumes an open universe ($\Omega_0 = 0.35$); the faintest galaxies are a red population of small protogalaxies ($z > 8$). Similar galaxies would also be present in a

closed universe ($\Omega_0 = 1.0$) but reduced in relative number by an order of magnitude. The same model also indicates that NGST, equipped with a mid-infrared ($\lambda > 5 \mu\text{m}$, MIR) capability, would be able to detect old ($\gg 100$ million year) stars in early galaxies with $z > 5$. This is important if star formation is as intermittent in early galaxies as it is today. With merging models, the simulated fields contain many faint small galaxies, the first galactic structures that only NGST can see.

Supernovae: Another Measure of Star Formation and the Geometry of the Universe

For several weeks a supernova can outshine its host galaxy and be seen across great distances. Supernovae occur from two very distinct stellar deaths: the collapse of a stellar core after a massive star exhausts all nuclear fuel (generally called Type II) and the explosive ignition of silicon burning that occurs when a carbon-oxygen white dwarf exceeds the Chandrasekhar stability limit (Type Ia). The Type II supernovae occur exclusively during periods of star formation and are a good, independent measure of star-forming rates. Moreover, association of supernovae with known redshifts with the faintest resolved sources may be the best way to establish the nature and distances of these faintest sources.

We think that Type Ia supernovae occur late in the evolution of lower mass stars, delaying their appearance for 0.5–1 billion years after the original stars are born. If this is true, we do not expect to observe a Type Ia with a redshift greater than $z > 5$ –10. Since Type Ia supernovae are nearly uniform in maximum brightness, they are good standard candles for measuring the apparent distances to galaxies. For large redshifts, $z > 0.1$, the apparent luminosity distance is different from the light-travel distance and includes the forward beaming of light due to the high recessional velocities and cosmological effects. By discovering and measuring the brightness of many distant supernovae at redshifts > 1 , we can measure the geometry of the universe. These results then can be compared with Big Bang model results from future microwave background measurements. Ground-based optical surveys for supernovae out to $z \sim 0.8$ will predate all these missions and will be the first to establish empirical values for the geometry and mass density of the universe. However, we believe that the cosmological issues and rates of star formation at epochs $1 < z < 3$ will not be settled by 2005 and that these observations will be an important goal for NGST. The HST and Beyond Committee emphasized the value of a large telescope to provide excellent sensitivity in the NIR and sufficient resolution to clearly separate the light of the supernova from that of the host galaxy. We can detect

supernovae with an 8 m diameter NGST to redshifts of $z \sim 10$ and obtain spectra of supernovae at $z > 6$. At these redshifts, we can measure in a straightforward manner whether we live in an open, low-density universe, $\Omega_0 \sim 0$, or a flat, critical-density universe, $\Omega_0 = 1$, which is favored by most cosmological theories. The differences between the two cosmologies are very large at high redshifts and are illustrated in Figure 1.4, along with the first measurements of supernovae at redshifts of $z \sim 0.4$. As the inset shows, the two possible universes are hard to distinguish at low redshifts even with excellent data.

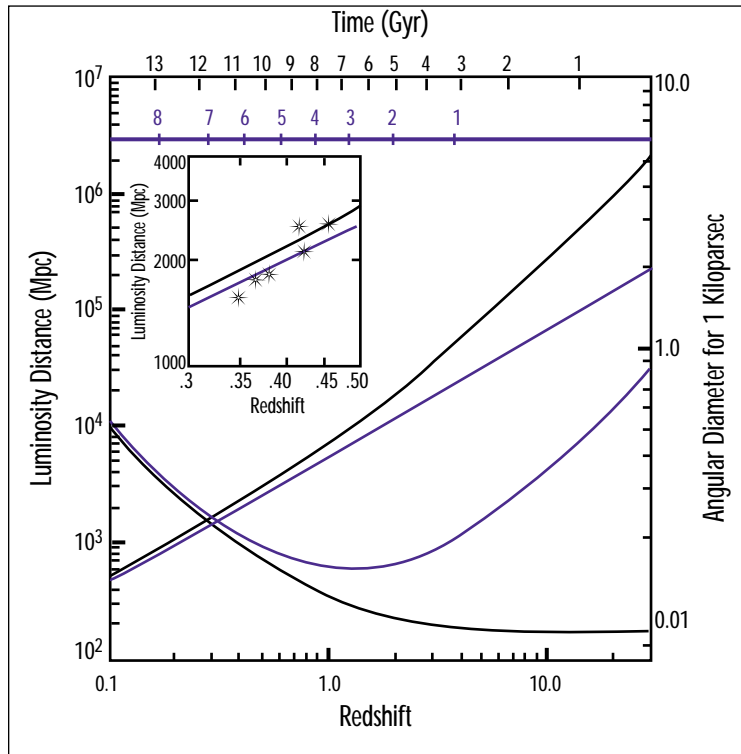

FIGURE 1.4. Detecting Supernovae at High Redshift. The effective luminosity distance/redshift relation is shown for two different cosmologies, as well as the time since the beginning of the universe and the apparent angular size of a 1 kpc region. We adopt a Hubble constant of $H_0 = 65 \text{ Km s}^{-1} \text{ Mpc}^{-1}$. Also shown are the early supernovae results of Perlmutter et al, 1997, for supernovae with redshifts $z < 0.4$. (ST Sci)

Seeing the Hidden Universe

The HST and Beyond Committee recommended that NGST “be operated as a powerful general-purpose observatory, serving a broad range of scientific programs” over a wavelength range determined by cost and technical difficulty. Of the many potential science programs that NGST could undertake, we highlight two properties of the infrared spectrum that provide new views of the nearby universe: the ability to penetrate dusty clouds and the spectral diagnostics that either are unavailable in visible and ultraviolet light, or are obscured by dust.

Much of the universe is hidden from our view by dust. Although each dust grain is tiny — less than the width of a human hair — it is remarkably effective at scattering and absorbing visible and ultraviolet light. Since light at longer wavelengths experiences less scattering, the effect of dust absorption and scattering is called “reddening.” Each generation of stars increases the amount of elements that will form dust, and regions of extensive star formation are often cloaked by the dust in the molecular clouds that form the stellar nursery. Some nearby star-forming galaxies are so dusty that we can only see the optical and ultraviolet light from the stars lying within the outermost skin of the star-forming region. The light from the hidden stars is absorbed by dust and re-radiated by the warm grains at $1 < \lambda < 100 \mu\text{m}$. The Infrared Astronomy Satellite (IRAS) discovered the long wavelength emission from warm dust within our own Galaxy and provided a complete survey of star-forming galaxies far beyond our Galactic neighborhood. The Infrared Space Observatory (ISO) and the SIRTf will study the galaxies discovered by IRAS and extend our view of dusty galaxies to cosmological distances. The ESA Far Infra-Red Space Telescope (FIRST) mission is designed to detect very luminous, star-forming galaxies at moderate redshifts ($z \sim 1-3$) that emit most of their light in the far infrared (FIR, $\lambda \sim 100 \mu\text{m}$). However, even objects heavily obscured by dust, such as the Circinus Galaxy and bright star-forming galaxies, such as Arp 220, are quite luminous in the NIR and could easily be detected by NGST to comparable redshifts and with better angular resolution. If most metals were made during the epoch $z \sim 1-3$, as suggested by the deep Hubble observations, we expect significantly less dust and absorption of starlight at higher redshifts.

As shown in Figure 1.5, our vision in the NIR ($1 < \lambda < 5 \mu\text{m}$) can penetrate thick dust clouds. In the MIR ($5 < \lambda < 30 \mu\text{m}$), we could see through clouds that are completely opaque to visible light (transmission $< 10^{-10}$). Our ability to view in the infrared the interiors of star-forming regions, the innermost portions of obscured AGN, and the dusty disks surrounding newly formed stars comes with a wide variety of diagnostic spectral features. These originate from common elements and molecules,

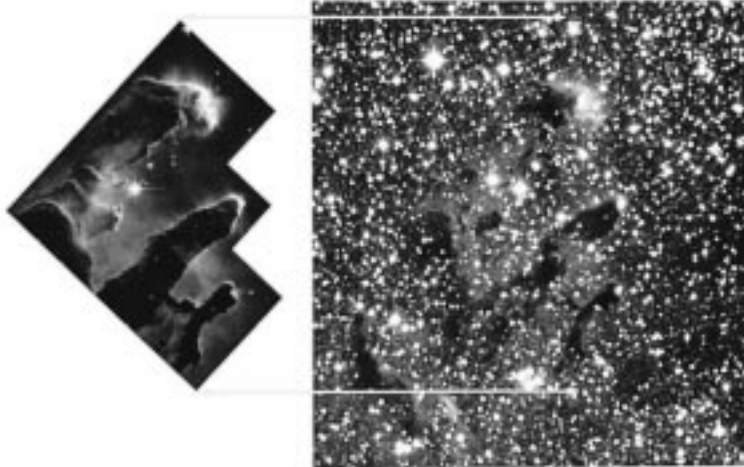

FIGURE 1.5. The Eagle Nebula as imaged by HST and a ground-based NIR camera. In the K band ($2.2\ \mu\text{m}$), the tall pillars of gas and dust are almost transparent. (HST/NASA and Calar Alto/MPIA)

such as hydrogen (H), molecular hydrogen (H_2) and carbon monoxide (CO). Others come from excited, metastable levels in ionized species (indicated by bracketed text in Table 1.1). More complicated molecular features originate from dust (e.g. silicates) and large polycyclic aromatic hydrocarbons (PAH). Each diagnostic improves our understanding of the environments in these hidden regions. Table 1.1 lists some of the most crucial diagnostic spectral lines and their uses. Of particular importance are the series of features from increasingly ionized neon (Ne), a noble element not locked within dust grains. A complete analysis of these lines and a luminosity indicator feature, such as the recombination Brackett series of ionized hydrogen, can provide metal content, reddening values and the strength of the ionizing radiation field. The PAH feature at $3.4\ \mu\text{m}$ is very common in star-forming regions, but is usually absent in AGN or other intense UV radiation fields. The silicate dust feature at $9.3\ \mu\text{m}$ is very strong within protoplanetary disks and is ubiquitous in dusty galaxies, including the Milky Way.

The ISO infrared spectrum of the dust-obscured AGN in the Circinus galaxy (Figure 1.6) is compelling evidence of both the shift in luminosity from the ultraviolet to the infrared and the richness and value in the IR-spectrum. The ISO and the SIRTf missions will be pathfinders in the diagnostic study of star-forming regions and the nuclei of galaxies. At greater distances or for complex sources, NGST will offer superior sensitivity and angular resolution in the NIR and MIR bands.

TABLE 1.1. Near IR and Mid IR Diagnostic Lines

Line Designation	Wavelength (μm)	Utility
H I Br $_{\beta}$	2.63	UV luminosity
Sulfates/bisulfates	2.3, 4.5, 9	Solar system studies
PAH/hydrocarbons	3.4	Dust, low UV
H I Br $_{\alpha}$	4.05	UV luminosity
CO $_2$ ice	4.26	Dust, solar system studies
[Mg VII]	5.51	Hot gas coolant
[Mg V]	5.60	General coolant, shocks
[Si VII]	6.50	Hot gas coolant, shocks
[Ar II]	6.99	Radiation intensity
[Ne VI]	7.63	Spectral index
Methane	7.7	Solar system studies
[Ar V]	7.90	Spectral index, reddening
[Mg VII]	8.95	Hot gas coolant
[Ar III]	8.99	Spectral index, reddening
Silicates	9.7	Dust
[S IV]	10.5	General coolants
[Ne II]	12.8	Radiation intensity, shocks
[Ar V]	13.1	Spectral index, reddening
[Mg V]	13.5	Spectral index, hot gas
[Ne V]	14.3	Spectral index, density
CO $_2$ ice	15.2	Dust, solar system studies
[Ne III]	15.6	Metallicity
H $_2$ (O-O) S(1,2, etc)	17.0, 12.3, etc.	Shock conditions
[S III]	18.7	General coolant
[Ne V]	24.2	Spectral index, reddening
[O IV]	25.9	Spectral index
[S III]	33.5	General coolant
OH	34.6	Radiative pumping
[Si II]	35	Shocks
[Ne III]	15.6, 36	Spectral index, density
[O I]	63	Shocks
[O III]	52, 88	FIR reddening, density

Where Does NGST Fit?

The HST and Beyond Committee recognized that its goals exceeded the sensitivities and resolutions of current or planned space or ground-based observatories. To observe the faint, redshifted light from distant galaxies, we must combine large apertures for light-collecting power and angular resolution with the low background provided by cold, space telescopes. Figure 1.7 indicates the planned point-source sensitivities for

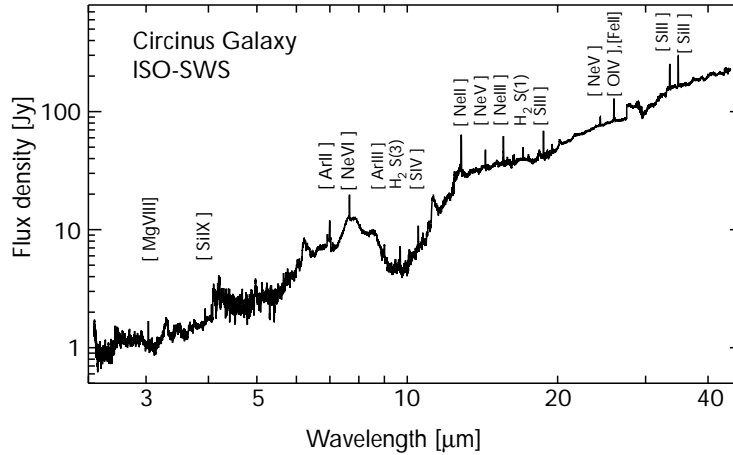

FIGURE 1.6. The ISO SWS spectrum of the Circinus Galaxy. The large absorption feature near 10 μm is due to silicates. The strong [NeV] and [Ne VI] emission lines are evidence for a strong soft X-ray flux from an active, central engine. (A. Moorwood/ESO)

Gemini (IR-optimized 8 m diameter telescopes in the northern and southern hemisphere 1998–2000), HST and the Near-Infrared Camera and MultiObject Spectrograph (NICMOS) (an NIR instrument that astronauts installed aboard HST in 1997), the Stratospheric Observatory for Infrared Astronomy (SOFIA) (an airborne 2.5 m diameter telescope scheduled to fly in 2000), and SIRTf (an 0.85 m diameter cryogenically cooled telescope slated for 2001–2006). We also calculate the sensitivity of 6 m and 8 m diameter NGSTs in two different orbits (1 AU and 3 AU) with an extended wavelength coverage of 0.5–30 μm . We show the theoretical spectrum of a star-forming protogalaxy at different redshifts to illustrate the promise and the need for such an observatory.

NGST Science Drivers

The HST and Beyond Committee’s vision of the science that will follow the HST mission has serious ramifications for the design of the successor mission. We call the motives and the capabilities that they require, the NGST “science drivers.” We illustrate them in Table 1.2 in the context of the NGST science studies which we introduce in this chapter and describe in more detail within Appendix C.

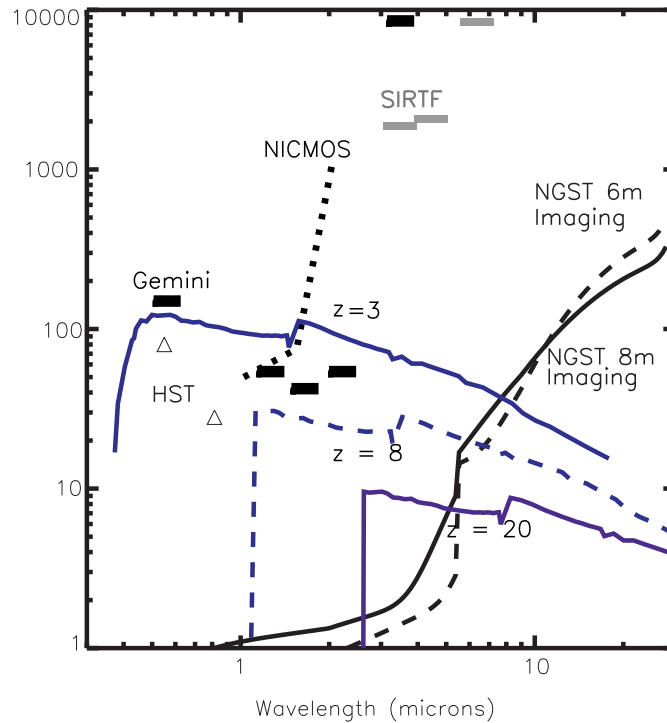

FIGURE 1.7. The sensitivity of planned 21st century observatories. The point source sensitivity is indicated for a 10^4 s exposure, a 10σ signal-to-noise precision, and a wide bandpass of $\lambda/\Delta\lambda = 3$. One nanoJansky (nJy) = 10^{-32} ergs cm^{-2} s^{-1} = 31.4 AB magnitudes. This is equivalent to 0.8 photon per second for an 8 m telescope and 100% bandwidth. We include the estimated sensitivities for NICMOS, SIRTf, and Gemini (with low order adaptive optics). The 6 m NGST is assumed to be at 3 AU and the 8 m NGST at 1 AU. The spectrum of the protogalaxy is shown at $z = 3$, 8 and 20 for $\Omega_0 = 1$ and $H_0 = 1$ and is provided by Leitherer and Heckman (1995) for a region creating $1 M_{\text{solar}} \text{ year}^{-1}$ in new stars over 25 Myr. Such a region would likely be resolved with NGST resolution. The two triangles correspond to the faintest galaxies discovered in the HDF at $z \sim 3$ and $z \sim 4$. (ST Scl)

These high priority science programs require capabilities that were foreseen by the HST & Beyond Committee:

- Sensitivity superior to HST and ground-based telescopes to detect very faint stars and galaxies,
- Angular resolution comparable to HST to clearly separate two nearby targets and avoid confusion and overlapping images,
- Wide field of view comparable or larger than HST to measure many objects at one time for surveys, and
- Optimized performance in the NIR portion of the spectrum to observe distant galaxies and stars and to survey heavily obscured regions of star and planet formation.

We can also see how an extended wavelength coverage would enhance the mission, particularly in the spectral regions overlapping those of HST and SIRTf. The MIR spectral region, ($\lambda = 5\text{--}28\ \mu\text{m}$), is essential for detecting the established population of stars surrounding high redshift starburst regions and, at the other extreme, Jupiter-mass objects forming today in nearby stellar nurseries like the Orion nebula. The next chapter describes how these science drivers can be implemented with NGST.

TABLE 1.2. The Major NGST Scientific Drivers: High Sensitivity, Angular Resolution, 1–5 μm Wavelength Coverage, and Wide Field Surveys¹

	Sensitivity	Angular	Wide Resolution	NIR Field	Opt. 1–5 μm	MIR
Early formation of stars and galaxies	★★★★	★★★★	★★★★	★★★★	★★★★	★★★★
Structure and dynamics of galaxies at $z > 2$	★★★★	★★★★	★★	★★★★	★★	★★★★
Distant supernovae	★★★★	★★	★★★★	★★★★	☆	☆
Kuiper Belt objects, proto-planetary disks	★★★★	★★★★	★★★★	★★★★	★★★★	★★★★
Stellar populations in nearby universe	★★★★	★★★★	★★★★	★★	★★★★	☆
Individual object classes	★★★★	★★★★	★★	★★★★	☆	★★★★

¹ ★★★★★ = high; ★★ = medium; ☆ = low.

CHAPTER 2

Seeing Beyond the Hubble Space Telescope

IN 1991, the Astronomy and Astrophysics Survey Committee of the National Research Council recommended that NASA and the NSF undertake two high-priority initiatives in the coming decade: SIRTf and the Gemini Project, which are twin 8 m diameter, IR-optimized, ground-based telescopes in the northern and southern hemispheres. These facilities are expected to become available possibly as early as 2001 and 1998, respectively; in the meantime, astronomers are making excellent progress using the ISO and the two Keck telescopes. In addition, the NICMOS, which astronauts installed aboard the Hubble Space Telescope in early 1997, will begin to bridge the wavelength gap between HST and SIRTf. Without doubt, these capabilities give astronomers an unprecedented view of the near infrared sky. However, the large (>4 m dia.) passively cooled Next Generation Space Telescope (NGST), which the HST and Beyond Committee strongly recommended, will provide orders of magnitude improvement over SIRTf and the Gemini Project in terms of sensitivity and high angular resolution over a wide field. This telescope will enhance our understanding of the universe, revealing the time and conditions of its origin. This chapter describes the advantages and requirements of an NGST. The NGST study has been greatly influenced by many other concepts of passively cooled telescopes, in particular the Passively Cooled Orbiting Infrared Observatory Telescope (POIROT) and the Edison Infrared Space Observatory and the Mid-Infrared Optimized Resolution Spacecraft (MIRORS).

Keeping Our Vision Sharp

To a layperson, a telescope makes distant objects appear larger and closer. Even with relatively modest instruments, amateur astronomers can easily see moon craters and other lunar features. What happens if

they use high power eyepieces? Will they get a better image? Professional astronomers all know the answer to that question. A more powerful eyepiece does not necessarily guarantee a better image. The wavelength of light and the size of the primary optic, D , set the ultimate resolution, approximately given by $\theta \sim \lambda/D$ in radian units. Simply making the optic larger does not result in better images once we reach a diameter of ~ 10 – 20 cm or resolutions of 0.5 – $1''$ (seconds of arc). Atmospheric temperature and corresponding density variations over larger scales cause the light from distant sources to suffer minute angular shifts. Even this level of image quality requires superior mountain-top sites and careful control of the telescope and dome design to reduce the effects of the atmosphere. New facilities, such as the twin 8 m Gemini telescopes, are designed to control all these factors.

Nevertheless, the near perfection of the optically corrected HST images illustrates the advantages of performing astronomy from space. Even under the best observing conditions, ground-based observatories cannot achieve HST's level of sensitivity and resolution. These advantages are very important for faint and complex targets. At the depths reached by HST and NGST, the images of small faint galaxies would blur and overlap with brighter foreground galaxies without HST-like resolution. Consequently, astronomers and engineers are making great efforts to reduce the effects of the atmosphere on ground-based observations. Using computer-controlled optical corrections, the new telescopes will track the 10 – 20 cm wide cells of uniform conditions in the upper atmosphere, as they traverse the 4 m to 8 m telescope beam and will modify the telescope optics accordingly. Using a laser beacon or a bright nearby star as a reference, this technique is limited by the altitude and size of the disturbing cells. For small cells at high altitudes, the light entering the telescope from neighboring stars suffers different distortions, making the optical compensations imperfect. As a result, astronomers can adequately correct only small angular regions of the sky. The angular size of these regions, the "field of view" (FOV), is set by the atmospheric cell size in the upper atmosphere, the number of adjustable optical elements or modes and the wavelength. For all conditions, the FOV is larger at longer wavelengths (approximately as $\lambda^{1.2}$). Within the compensated FOV, the new 8 m diameter ground-based observatories will likely achieve HST-like resolution ($\sim 0.1''$) in a restricted portion of the NIR ($2.2 \mu\text{m}$) and over a modest ($0.5' \times 0.5'$) field of view. This is a major capability and is essential for the spectroscopic study of bright high redshift galaxies revealed by HST ($1 < z < 3$). Outside this narrow field of view, ground-based telescopes will have blurred images, about 0.25 – $0.5''$ in angular diameter in the best of conditions. Ground-based surveys of faint galaxies and rare objects such as supernovae, are hampered by this atmospheric tunnel vision (Figure 2.1).



FIGURE 2.1. A comparison of a simulated NGST image with 0.06" resolution (left side) at the K band and one with 0.25" resolution (right side). Note that many of the faint galaxies are lost in the latter image because of confusion and lower sensitivity (ST ScI).

To enable the study of more typical galaxies and objects at even greater distances, the HST and Beyond Committee envisioned a space-based facility with angular resolution comparable to HST within the optimum wavelength range (1–5 μm) and a wide FOV for the faint surveys. Because of diffraction, this requires the NGST primary mirror to have at least a 4 m diameter to obtain 0.06" resolution at $\lambda = 1 \mu\text{m}$. Larger-diameter telescopes are preferable because they achieve HST resolution deeper in the IR and are much more sensitive because of their increased collecting area. Unfilled arrays (a collection of mirrors widely separated) also can achieve HST resolution, but at a loss in sensitivity and FOV.

Cutting Out the Glare

Seeing faint galaxies requires superb sensitivity. Even an 8 m diameter telescope will receive less than a photon per second from distant star-forming regions at redshifts of $z \sim 10$. Therefore, a very high premium is placed on the efficiency of collecting and detecting that photon, the telescope and instrument quantum efficiency (QE). However, in the infrared, the greatest challenge is overcoming the natural and instrumental backgrounds, signals that may swamp the light from a faint galaxy. The detection system often produces the greatest background and noise. For modern infrared arrays, individual detector elements or "pixels" may contribute thermal and electronic backgrounds of 0.04–1

electron per second ($e\ s^{-1}$). At wavelengths longer than $1.6\ \mu\text{m}$, a warm telescope and its instrument optics will glow and add to the background level. Over most of the NIR and at all MIR wavelengths, airglow due to excited molecular species overwhelms all other background sources for ground-based telescopes. However, for space observatories, most of the external background between $0.2\ \mu\text{m}$ to $30\ \mu\text{m}$ is zodiacal light, scattered and re-radiated sunlight. The scattered component follows the spectrum of the Sun and dominates for wavelengths shorter than $\lambda < 3.5\ \mu\text{m}$ for Earth's distance from the Sun (1 Astronomical Unit [AU]). Beyond $3.5\ \mu\text{m}$, the thermal radiation from warm, interplanetary dust is greater than the scattered sunlight. The temperature of the dust at 1 AU is approximately 266K, and its thermal radiation peaks near $\lambda \sim 10\ \mu\text{m}$. Farther from the Sun, the intercepted sunlight and the temperature of the dust decrease. For a telescope at 3 AU, near the outer portions of the asteroid belt, the zodiacal background would be 30 to 100 times lower, with the rise in the thermal radiation beginning at $\lambda \sim 5\ \mu\text{m}$. Figure 2.2 illustrates the enormous difference between the atmospheric background and the backgrounds achievable in space. The random arrival rate of background photons sets the lowest possible noise or uncertainty for a measurement. For measurements of very faint sources, those fainter than the background, the sensitivity is inversely proportional to the square root of the background. By the same token, the time to achieve a given sensitivity is directly proportional to the background. Thus, the 10^2 to 10^8 differences in background shown in Fig. 2.2 could correspond to detecting objects 10 to 10,000 times fainter. Infeasible, year-long observations from the ground are done in 0.1–1,000 seconds from space. The lower backgrounds achievable in space are the primary motivation for cold telescopes such as ISO, SIRTf and NGST. Figure 2.2 also indicates why cool optics are important. For the 1 AU telescope, we assume that the primary mirror temperature is $T_{\text{mirror}} \sim 50\ \text{K}$, and its glow exceeds the zodiacal light at wavelengths longer than $\lambda > 18\ \mu\text{m}$. For the 3 AU telescope, we assume that the mirror temperature can be reduced to 30 K, shifting the crossover to longer wavelengths, $\lambda > 20\ \mu\text{m}$. The higher temperature telescope is acceptable for the core science program, but it does not take advantage of the low natural backgrounds at longer wavelengths.

The design of the telescope aperture also affects the ultimate sensitivity. Because of diffraction, we need to choose between resolution and sensitivity. For the same aperture area, the angular resolution improves as we separate the reflecting surfaces and recombine their light using interferometric techniques. On the other hand, optimum sensitivity is achieved by using a conventional single aperture or adjoining segments (a filled aperture). The widely separated reflecting surfaces create a more complex image, one that covers more detectors and

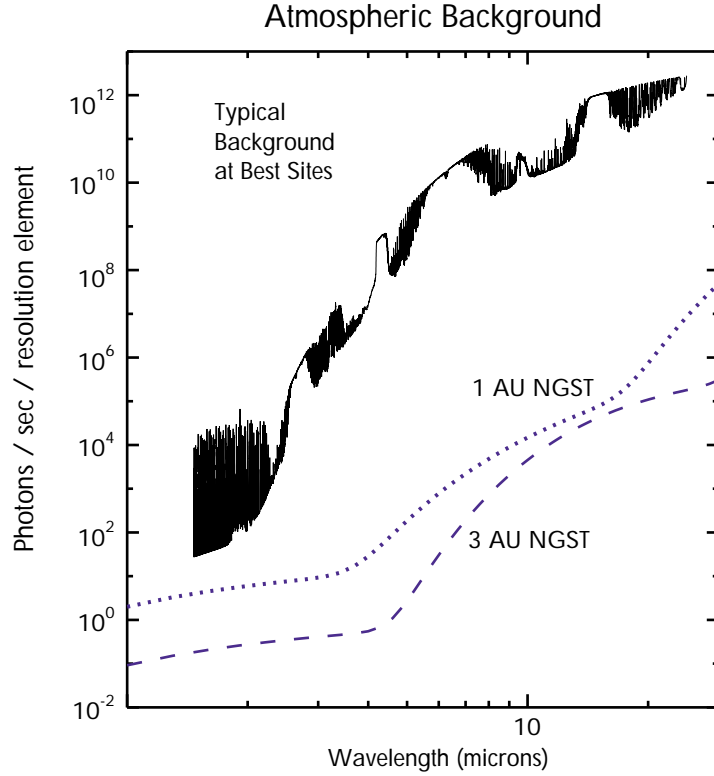
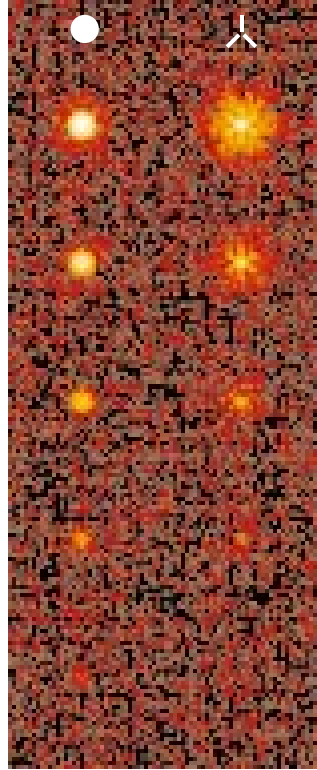

FIGURE 2.2. A model atmospheric background for Mauna Kea compared with an optimum zodiacal light background at 1 AU and 3 AU. The primary mirrors are assumed to have 3% emissivity and temperatures of 273, 50, and 30 K, respectively. The background units are expressed as photons per second, 100% bandpass, and angular resolution element (λ/D) and are independent of telescope aperture. (ST Scl)

more background. The result is that faint signals become lost. Figure 2.3 illustrates this result using a constant background and two different mirror designs. Since the NGST science program places the highest priority on sensitivity, we find from analysis of the Design Reference Mission (Appendix C) that a filled aperture telescope design is more efficient. However, a circular shape is not required. An aperture with a hexagonal or rectangular shape performs as well as a conventional, round mirror. A long rectangular aperture is also efficient but must be rotated by 90° between exposures to yield high-resolution images.

FIGURE 2.3. A single aperture has better sensitivity than an array of apertures. The figure shows broad-band ($\lambda/\Delta\lambda = 3$) stellar images obtained by a single, conventional 8 m telescope and those obtained by a “y” shaped aperture of equivalent area (the Lockheed Martin MultiAp concept). For bright objects, the “y” shaped aperture can provide better resolution, but it has lower sensitivity for detecting faint stars and galaxies. (Krist/STScI)



The NGST Needs a Good Home

Besides the large primary mirror, the large passively cooled NGST and the large ground-based telescope share many common design elements. Both facilities require insulation and stray-light shields. Sunlight should not heat the interior of the ground-based telescope since ground telescopes work best when they are at the same temperature as the night air. Solar heating must be reduced by a factor of 10,000 in NGST. In the shade, the NGST optics and science instruments will slowly cool by their own radiation to very low temperatures, $T_{\text{mirror}} \sim 50$ K.

Pointing is as important as good image quality. Both ground-based and space-based telescopes use two layers of pointing control to reduce image jitter to acceptable levels. The first relies on mechanical

stability; the second uses nearby stars as pointing beacons. Modern mountaintop telescopes also resemble space missions in their use of remote communications, operations and flexible scheduling. Astronomers may still travel to distant and exotic sites to oversee their observations. There, they work at remote consoles and peer at television monitors, lest heat from their bodies and instruments disturb the atmospheric conditions in the telescope dome and ruin their images. *In many ways, HST and future observatories such as NGST take the search for the perfect astronomical site and perfect conditions to the logical site: outer space.*

A good site and sky availability also are important elements in the NGST design. Chapter 5 outlines the advantages of an NGST solar orbit compared with a low Earth orbit (LEO) or geosynchronous Earth orbit (GEO). The ability to observe a large portion of the celestial sphere under prime conditions is just as important for NGST as the ability to take long exposures near the zenith for ground-based telescopes. To minimize the zodiacal background, we wish to point almost perpendicular to the plane of our solar system — almost at right angles to the Sun-Earth line ($\sim 76^\circ$). In this direction, near the ecliptic poles and tilted slightly away from the Sun, the reflection of sunlight and the amount of emitting dust in the NGST line of sight are lowest. Likewise, astronomers will pick regions near the poles of our galaxy that minimize the obscuration and reflection of starlight from dust in our galaxy. The Hubble Deep Field was as close as possible to these ideal regions. Another clear area through our galaxy, the “Lockman Hole,” lies out of the ecliptic plane and will be a prime target for EUV, X-ray and NGST missions. These regions are shown in the upper panel of Figure 2.4. The three prime concepts for NGST are remarkably different in their access to these targets (see Chapter 4). The TRW concept, using an adjustable angle between the primary mirror and the deployable sunshade, is capable of observing any point on the sky for 6 months per year. The GSFC concept uses a fixed orientation and has favored regions near the ecliptic poles, which are observable 6 months per year. The mission concept proposed by Lockheed Martin travels an elliptical orbit from 1 to 3 AU (1×3 AU) and uses a fixed shield geometry like the SIRTf mission. During most of the 2.8 year period, it is near 3 AU and views a restricted portion of the celestial sphere. We can place an important region, such as the Lockman Hole, in this favored region using a restricted launch window. In the bottom two panels of Figure 2.4, we can see how the GSFC and Lockheed Martin concepts differ in their coverage of the celestial sphere. The 1×3 AU orbit provides the lowest possible zodiacal background, but only for about half of the celestial sphere.

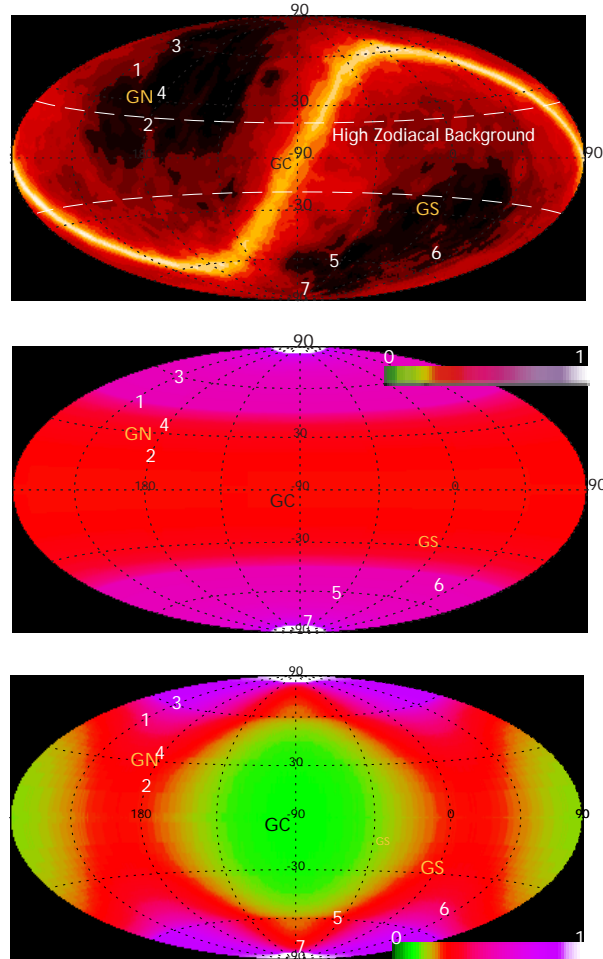

FIGURE 2.4. Sky Map in Ecliptic Coordinates; access for 1 AU and 3 AU satellites. The upper panel shows the zodiacal background and the galactic H_2 column density in ecliptic coordinates, as well as several selected regions. The numbers correspond to key NGST targets: 1) Lockman Hole, 2) Virgo Cluster, 3) HDF, 4) Coma Cluster A, 5) Small Magellanic Cloud, 6) Large Magellanic Cloud, 7) Fornax Cluster. The Galactic poles and the Galactic Center are also indicated. The middle and bottom panels show the access to various parts of the sky for the GSFC and Lockheed Martin concepts. We have chosen a launch date for the Lockheed Martin concept that places the Lockman Hole in the 30% optimum viewing area. (Koratkar/STScI)

Science Instruments and Detectors: Capturing the Light

The goal of NGST is to gather light from distant stars and galaxies and present a crisp image for measurement and detection. The measurement and detection complete the task and greatly affect the overall performance of the observatory. In the concept and early design phase, we reviewed the state of the art of NIR scientific instrument design and created preliminary, “strawman” instrument designs (see Chapter 7). Matching these designs to the telescope, in turn, forced us to modify the overall telescope prescription. This process of iteration is essential and will continue throughout the NGST concept, design and development phases. The scientific goals of NGST require combining the best existing elements in optical and NIR instrument design: large fields of view, low background and state of the art thermal and optical design. The chief components are the detectors, where the light is finally captured and converted into electronic signals for storage and transmission.

The basic requirement for the NGST detectors is that they efficiently and noiselessly detect each precious quantum of light in the desired wavelength band. To the layperson, this may sound preposterous; but near perfect, essentially noiseless detection is almost commonplace in modern, solid-state optical detectors (charge-coupled detectors or CCDs). Unfortunately, the silicon-based CCDs become transparent at IR wavelengths ($\lambda > 1.1 \mu\text{m}$). Modern IR detectors, which are hybrids of silicon wafer electronics and exotic infrared-absorbing material, work remarkably well, with excellent quantum efficiencies (QE) of detection, formats (numbers of elements) and noise properties approaching those of CCDs. Three different absorbing materials hold great promise; indium antimonide (InSb, useful from 0.6–5.5 μm), various alloys of mercury cadmium telluride (HgCdTe, 0.8–12 μm), and silicon, which has been bombarded or doped with other elements such as arsenic, (Si:As, 5–28 μm). Chapter 7 describes the state-of-the-art for these devices. Here we describe the required properties.

Wavelength Range and Operating Temperatures

The NGST science program takes advantage of the floor of the zodiacal light background, between 1 and 5 μm . The Design Reference Mission also includes observations in the visible band and MIR ($\lambda = 5\text{--}28 \mu\text{m}$). The four solid-state detector types discussed above can conveniently cover that range, but would operate at different temperatures. CCDs operate at temperatures of approximately $T \sim 180\text{--}200\text{K}$. This

temperature is significantly higher than $T \sim 30$ K envisioned for the NGST instrument package, but it could be accommodated with careful thermal design. At the other extreme, operating Si:As in the $\lambda = 10\text{--}28$ μm range requires very low temperatures, $T \sim 6\text{--}8$ K, to achieve the ultimate low-noise performance. Thus, we may need to add some form of active cooling, besides passive radiation, to extend the wavelength range beyond the $\lambda = 1\text{--}5$ μm core requirement into the MIR.

Resolution, Field of View, and the Number of Pixels

NGST must have HST-like resolution and a wide field of view to accomplish deep, sensitive imaging and spectroscopic surveys for distant and rare phenomena (e.g., the largest star-forming regions and structures at high redshift, supernovae, protostars in the Orion nebula, and large Kuiper belt objects with orbits far beyond Neptune). Many optical prescriptions can provide a diffraction-limited FOV in excess of 10 arcminutes in diameter. If we wish to properly sample this entire field at HST resolution, 0.06 arcseconds, we would need approximately $20,000 \times 20,000$ (20k x 20k) pixels. In comparison, the largest astronomical IR device in use is 1k x 1k. We describe in Chapter 7 how large

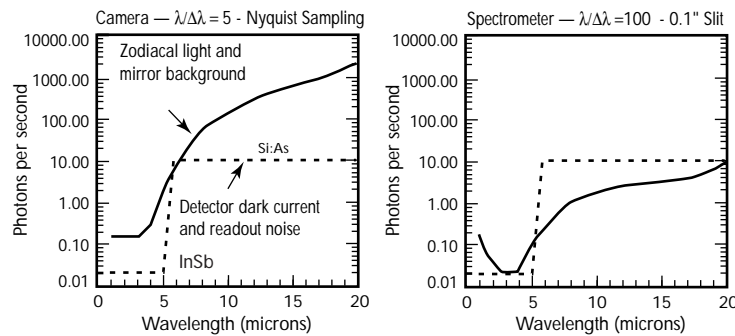

FIGURE 2.5. Zodiacal light background (solid line) and thermal optics emission (dashed line) for an 80% filled 8 m diameter telescope, for broad band imaging (left) and for low-resolution spectroscopy (right). The dotted line indicates the contribution to the background due to dark current and readout noise in the detectors. The calculation assumes Nyquist sampling in the middle of the NIR band (2.3 μm) and MIR band (9 μm) in the case of imaging and an angular resolution of 100 milliarcsecond for spectroscopy. The temperature of the main telescope optics is taken as 50 K. (ST ScI)

fields can be constructed from hierarchical groupings of 1k x 1k detectors. At longer wavelengths, we require fewer detector elements because the angular resolution increases with wavelength while the angular field is fixed. At $\lambda \sim 20 \mu\text{m}$, for instance, we would need only a 2k x 2k device to image the entire FOV and retain essentially perfect resolution. In practice, other important considerations such as cost, production yield, available instrument volume, and data rates will guide our choice of usable FOV.

Dark Current and Full Wells

Like the famous science film, “Powers of 10,” we must zoom into the microscopic realm of the individual detector pixels to complete our understanding of the NGST observatory. Here, in the photon-absorbing layer and the individual pixel electronics, we find the keys to superb performance. The technical details are beyond the scope of this report, but we can comment on their effects. Within the state of the art, we can optimize the design of our pixels by changing their physical size and their electronic circuits. By increasing the size of the pixel, we can increase the amount of light that a given pixel can detect before saturation, its “full well.” By reducing the size of the pixel, we can minimize the amount of leakage currents or dark currents that contribute to the detector noise. Full wells set the maximum brightness of an object in a single exposure—the dynamic range. The dark current, on other hand, must lie comfortably below the natural zodiacal light background and the thermal radiation from the telescope and instrument optics. Figure 2.5 shows that this is not an easy task, particularly for the spectroscopic devices that break the image into hundreds of spectral elements—each with its own detector noise. To place the detector noise below the background for ultrasensitive spectroscopic observations, we require that the NIR dark currents be less than $0.02e \text{ s}^{-1}$ and that the MIR dark currents be $< 5e \text{ s}^{-1}$. Even making measurements this sensitive in the laboratory is very difficult. However, modern NIR and MIR detectors are approaching this performance. We have great confidence that they will reach these goals in the next 3–5 years, while retaining adequate full wells ($>60,000 \text{ e}$, or dynamic range $>10,000$).

Read-out Noise and Schemes for Reducing It

The process of converting the accumulated charge signal in a given pixel to digital data is intrinsically noisy. The signal is always corrupted by small and unpredictable electronic noise. With CCDs, we can achieve a performance almost sufficient to detect individual electrons—corresponding to individual photons—with noise less than 1 root-

mean-square (RMS) electron per conversion (read-noise < 1 e RMS). Current IR detector performance is approximately 50 e RMS per read and probably can be reduced to 20 e without major advances in technology. At 20 e RMS, this noise is comparable to that from a dark current of $(\text{RMS noise})^2/\text{time}$ or 0.4 e s^{-1} for a 10^3 s exposure, which is unacceptable in the NIR. However, we can reduce this noise by repeatedly reading the same pixels and averaging the results. The number of reads reduces the effective dark current proportionally. To reach our goal of $< 0.02 \text{ e s}^{-1}$, we will look for lower intrinsic read noise performance and incorporate multiple readouts per observation. We also will utilize the longest possible integration times before resetting the individual detectors and beginning another round of sampling. For space missions, however, we must limit the length of a given exposure because of spurious signals due to cosmic rays. We estimate that NGST at L2 will be capable of exposures of 250–1000 s before the cosmic ray flux has affected more than a few percent of the number of pixels. By using many exposures, we can identify and remove the cosmic ray signals. The price of the multiple reads and limited exposure times is very high data rates to the instrument computer and, eventually, to the ground (~ 100 million bits per sec, Mbps and > 1 Mbps respectively, see Chapters 8–9). In Table 2.1, we summarize some of the desired characteristics of the detectors. These goals should be achievable over the next 3–5 years with modest NASA and Department of Defense (DoD) investment.

TABLE 2.1. Desired Detector Array Characteristics

Parameter	NIR	MIR
Wavelength range (μm)	0.5–5	5–30
Total number of pixels	8k x 8k	1k x 1k
Possible focal plane array size (mosaic)	4k x 4k	1k x 1k
Possible individual array size	1k x 1k	512 x 512
Dark current (e s^{-1})	< 0.02	< 1
Single sampling readout noise (e read^{-1})	< 15	< 15
Quantum efficiency (%)	> 80	> 50
Full well (e)	$> 60,000$	$> 60,000$
Read time for entire array (s)	< 12	< 12

Other Possible Future Facilities

As part of the NGST study, we considered other facilities that may be operating in the same time frame, namely future projects studied by the Gemini Project and ESA. The Gemini Project considered two ground-based facilities that would undertake the study of galaxies discovered in deep HST images. These were a huge, single dish telescope with a 30 m diameter aperture and a widely spaced optical interferometer with sixteen 8 m diameter telescopes on a 1 km baseline. The ESA science goal was superior resolution in the optical and NIR. The optimum configuration was a constellation of 1 m telescopes, placed at the L2 Lagrange point (see Chapter 5) and separated by up to 1 km. To these studies, we add a deployed 8 m diameter passively cooled telescope at L2. Table 2.2 lists the relevant details of the four facilities.

We take two obvious lessons from Table 2.2. First, all the new facilities, including the ground-based telescopes, will be comparably expensive. The giant ground telescope would be ideal for very high-resolution spectroscopy of individual moderate-redshift galaxies due to its great collecting area. The two interferometers are better for very high resolution imaging of bright, nearby targets (stars, star-forming regions, galactic nuclei and quasars). However, they will be unable to detect the faint galaxies and star-forming regions that are the targets for NGST. For the study of the early universe, we must choose an NGST-type space telescope with superior sensitivity, wide field of view and wavelength coverage.

TABLE 2.2. Possible New Facilities for the Period 2005–2015

Telescope Design	λ (μm)	Resolution at 2.2 μm (arcsec)	FOV (diameter in arcsec)	Relative Imaging Signal/Noise ¹	Development Cost (1996)
50 m giant dish	1–3	0.02	10–20	36	\$1,061M
Sixteen 8 m telescopes	1–3	0.001	3–5	1–4	\$892M
Six element ESA array	0.5–12	0.0004	0.1	10 ⁻²	\$700M ⁺²
8 m NGST	1–5	0.06	240	200	\$500M ⁺²

¹The signal to noise for a faint point source compared to an optimized 8 m groundbased telescope.

²Does not include technology development.

The Performance of the Next Generation Space Telescope

We can estimate NGST's performance using a single criterion: the speed or inverse of the time to achieve a given signal-to-noise on different targets, either resolved (e.g., nearby galaxies and nebulae) or unresolved (stars, AGN, very distant galaxies or star clusters). With greater speed, we can observe more targets or obtain comparable data for fainter sources. We use the same criterion and equations for analyzing the NGST science program (Appendix C). For faint sources, our formula for the required time can be expressed as (WFPC2 Handbook):

$$t = \frac{\sqrt{tFAE}}{\sqrt{n(\lambda, target) \cdot B(E, t, \lambda)}}$$

Here, $S(t)$ is the signal-to-noise expressed in standard deviations; t is the duration of the observation; F is the target flux in photons $m^{-2} s^{-1}$; A is the collecting area in m^2 ; E is the efficiency; $n(\lambda, target)$ is the effective number of pixels covered by the target ($n = 1/\sum_{ij} I_{ij}^2$); and $B(E, t, \lambda)$ is the background signal in each pixel due to natural backgrounds and detector noise in equivalent photons s^{-1} . This formula includes many different effects. In particular, the effects of resolved images, the telescope imaging performance, and the choice of detector pixel size are buried inside the term $n(\lambda, target)$ by using the normalized image profile in pixel coordinates, I_{ij} . For instance, using more pixels to resolve an image leaves the ratio $1/nB$ unchanged until detector noise overcomes the contribution of the external backgrounds. This is one reason why broadband interferometers, which must use many pixels per target, are less sensitive than filled aperture telescopes. More directly, the formula reveals several key dependencies for telescopes with identical configurations:

- The performance or speed is inversely proportional to the background. We infer from the background levels shown in Figure 2.1 that a 8 m diameter telescope in space should be 10^2 – 10^6 faster than an 8 m telescope on the ground, depending on wavelength.
- The performance is directly proportional to A^2 . A space-based 8 m telescope is 16 times faster than a space-based 4 m telescope. This assumes that the angular resolution scales inversely with the diameter.

- The time to reach fainter sources is inversely proportional to the square of the brightness. That is why the faint limit for a given observatory is so well defined. Imaging a source 10 times fainter than one detectable in one day can take an entire year! In terms of distance or redshift, the dependence is even greater: observing a source 10 times more distant would require 10^4 times more time for the same facility.

In Fig. 2.6, we show the relative performance or speed of other facilities relative to an 8 m NGST at 1 AU. Our model is based upon the GSFC concept study and uses the zodiacal background near the ecliptic poles. The great differences in speed are mostly due to different backgrounds or, in the case of NICMOS, to aperture size and field of

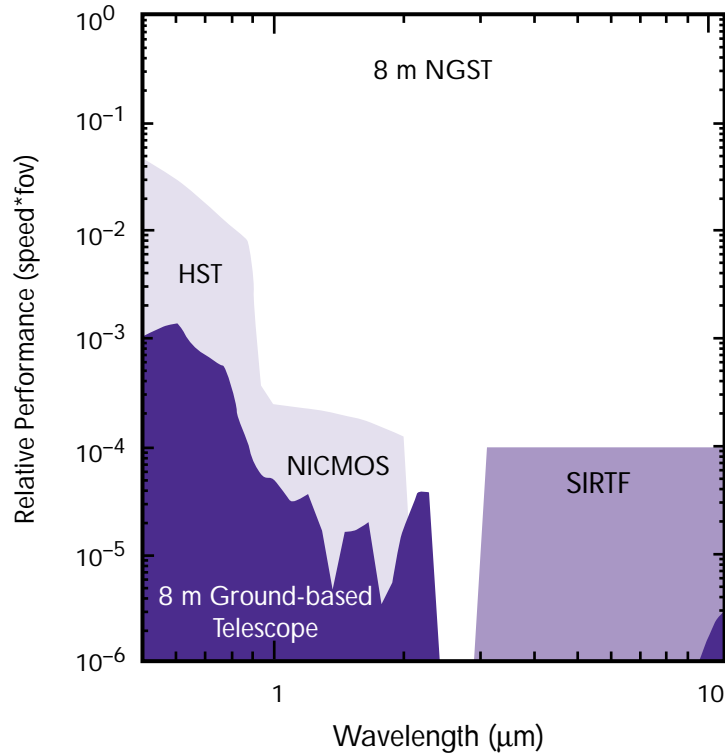

FIGURE 2.6. The performance of an 8 m NGST telescope at 1 AU relative to other facilities planned for the 2005-2010 era. In the upper panel, we indicate the relative value of a day of observations for each of these facilities compared with NGST for wide-field, diffraction-limited imaging ($4' \times 4'$, $\lambda/\Delta\lambda = 3$). (STScI)

view. In Figure 2.7, we show the limiting point-source flux for an 8 m NGST (1 AU) and a 6 m NGST (3 AU), for a 10σ detection in 10^4 s and a 33% bandwidth ($\lambda/\Delta\lambda = 3$). For low-resolution, imaging spectroscopy with $\lambda/\Delta\lambda = 100$, we obtain the same speed advantages for the two NGST concepts compared with the other facilities, but the limiting flux is approximately 20 times greater than that for $\lambda/\Delta\lambda=3$. For moderate-resolution spectroscopy, $\lambda/\Delta\lambda = 1000$ or greater, the performance of the two NGST concepts depends on detector noise and not natural background. Nevertheless, the NGST observatory will retain a hundred-fold performance advantage over ground-based telescopes and SIRTf for $\lambda > 1 \mu\text{m}$. At still higher spectral resolution, $\lambda/\Delta\lambda \gg 5,000$, we expect that ground-based astronomers will peer between the atmospheric emission bands throughout most of the $\lambda = 1\text{--}3 \mu\text{m}$ region. They will use very high-spectral resolution instruments on SOFIA ($\lambda/\Delta\lambda > 100,000$) for sources that are literally too bright for NGST. For that reason, we have not emphasized high-resolution spectroscopic capabilities on NGST. We also indicate theoretical spectra for representative targets in the HST and Beyond science program.

These comparisons show that NGST is the only telescope capable of the following studies:

- Determining the morphology (shape) and velocity dispersion (temperature) of the established stellar populations in galaxies near the peak in merging and star formation ($z \sim 1\text{--}3$). This requires high-resolution imaging and $\lambda/\Delta\lambda = 1000$ spectroscopy;
- Establishing the luminosity function and the ratios of old stars to new stars for star-forming regions during the early-merger period ($4 < z < 12$). High resolution, wide-field imaging and low-resolution spectroscopy, $\lambda/\Delta\lambda$, are needed;
- Detecting the first epoch of star formation and seeding the early universe with heavy elements ($10 < z < 30$). Ultra-faint imaging will reveal the faintest, high-redshift star-forming regions. Repetitive surveys will reveal new supernovae, which then will be confirmed by low-resolution spectroscopy;
- Following and extending the MIR discoveries of SIRTf — imaging and spectroscopy over an extended, wide wavelength range, $5 \mu\text{m} < \lambda < 30 \mu\text{m}$.

Other facilities cannot reach the critical sensitivity levels or provide the critical angular resolutions over large fields of view. *The science is compelling; the general advantages of a large, passively cooled space observatory are clear.* The remainder of this report addresses the question “Is NGST feasible with tomorrow’s technology and today’s budgetary constraints?”

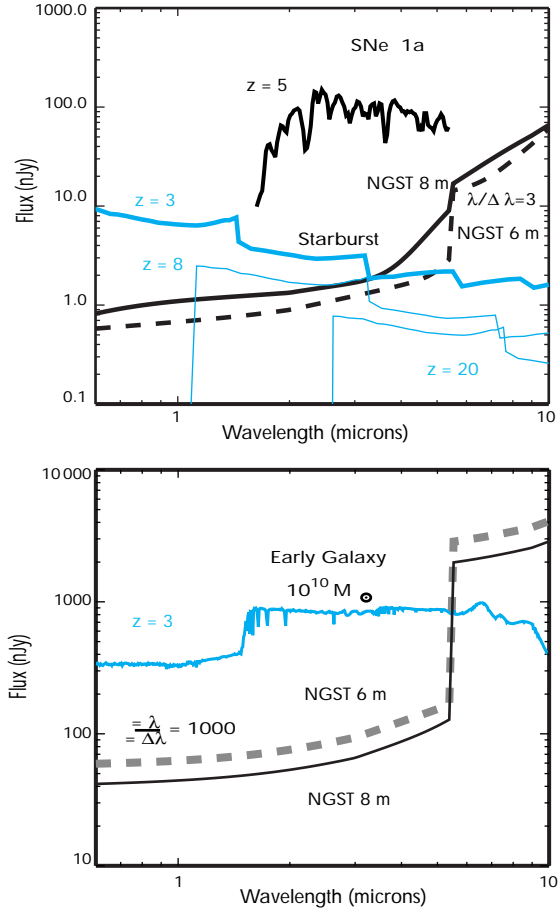

FIGURE 2.7. The limiting flux sensitivities of two NGST concepts with different diameters and different zodiacal light backgrounds. The upper panel indicates the value for a 10σ detection in 10^4 s and a broad band, $\lambda/\Delta\lambda = 3$. Also shown are the theoretical spectra for a bursting primeval star-forming region, $10^6 M_{\text{solar}}$ at $z = 3, 8$ and 20 (Leitherer and Heckman, 1995, Salpeter IMF and low metallicity). We also show a Type Ia supernova (SN 1992A, Kirshner et al, 1993) at a redshift of $z = 5$. In the lower panel, we show the sensitivity for wide-field, moderate-resolution spectroscopy (10σ per waveband, 10^5 s and $\lambda/\Delta\lambda = 1000$). In this panel, we show the theoretical spectrum of an established stellar population, $10^{10} M_{\text{solar}}$, for a $z = 3$ galaxy after 10^9 years of continuous star formation (Bruzal and Charlot 1996). ($\Omega_0 = 1$, $H_0 = 50$). NGST would resolve such a large galaxy comparable to our Milky Way and discern its internal dynamics. (STScI)

CHAPTER 3

The NGST Challenge: Establishing Feasibility

THE HST and Beyond Committee report and Chapters 1 and 2 of this report make a strong scientific case for developing a large-aperture, IR-optimized space observatory. Before a mission like NGST finds a place in the NASA long-range plan, however, we must show that it is technically feasible and affordable. In October 1995, the HST Project Office of the Goddard Space Flight Center (GSFC) initiated a feasibility study for such an observatory as part of NASA's "Astronomical Search for Origins and Planetary Systems" (Origins) initiative. Participants agreed that GSFC would lead the effort, with the Space Telescope Science Institute (STScI) providing scientific support. The two-year study was joined by other NASA and government centers, the aerospace industry, and the academic community. The Marshall Space Flight Center (MSFC) provides expertise in the development of large, lightweight optics; the Ames Research Center provides infrared detector expertise; the Jet Propulsion Laboratory (JPL) helps with new-technology development and the active control of lightweight structures and optics; and the Langley Research Center (LaRC) offers expertise on control of deployable structures. The task was formidable. NASA Headquarters and the GSFC HST Project adhered to the following scientific and technical study goals:

- The large-aperture (>4 m dia.), passively cooled telescope concept must be capable of accomplishing the scientific goals of the "HST and Beyond" Report.
- Technology development, mission construction, and launch should happen by as early as 2005.
- Total costs, including construction, launch and operations (excluding technology development or data analysis) should be < \$900M (1996). The estimated cost of construction is < \$500M (1996). Technology-development costs could be assumed to be as much as 20% of the total mission cost.

To those familiar with the development histories and costs of the "Great Observatories," which include CGRO, HST, AXAF (to be launched in 1999), and the original SIRTf concept, these goals imply major changes in the way NASA must do business. For one, the Great Observatories were originally designed for Shuttle deployment in LEO. Second, they were massive and expensive-to-build structures. In fact, HST development costs exceeded \$1.6B (1990). Third, the operations costs also were very high, because the LEO satellites must communicate using the NASA constellation of geosynchronous satellites servicing both NASA and classified DoD missions.

On the other hand, the successful 1993 and 1997 HST servicing missions validate the concept of a Shuttle-based maintenance and refurbishment program that reduces the risks of expensive development programs. Future programs that eschew Shuttle servicing to reduce development and transportation costs must provide other compensating risk reduction strategies. The reprogrammed SIRTf mission, for example, is designed with no moving parts or deployable structures, items that sometimes seem to provide more than their share of malfunctions in space. The NGST concepts must go one step further. They must achieve the low cost and simplicity, while using the most advanced optical and structural technologies for the large telescope optics and supporting structures.

Fortunately, we have many examples of existing and planned satellites that accomplish many of the NGST cost reduction goals. Modern geosynchronous communication satellites routinely operate longer than 10 years, without Shuttle visits or excessive redundant circuitry. As a result, the designs of new, mid-sized science satellites often begin with a commercial spacecraft "bus," which provides communications, power, and attitude control. The economy-of-scale comes not from using common spacecraft mechanical structures, but from standard commercial spacecraft subsystems. Like desktop computers, these subsystems are linked to the spacecraft local area network and are controlled by standard software on the flight computer. But the NGST technical and financial goals are far more challenging than simply using existing 1996 hardware. We must literally create the technological environment in which all of the spacecraft and operations can be designed and acquired with confidence. It is this advanced technology that, together with new ways of doing business, will enable the NGST science mission for the lowest possible cost to the public.

The NGST Science Drivers

Establishing the major science drivers for the observatory is the first step toward the study of any scientific facility. For NGST, the HST and Beyond Committee provided the high-level science drivers for the study of the early universe:

- High sensitivity (>10 times that of modern ground facilities);
- Low confusion (resolution comparable to HST);
- Optimized performance in the near-IR for high-redshift observations, ($\lambda=1-5 \mu\text{m}$);
- Wide Field Surveys for rare objects and cosmological structure (simultaneous imaging/spectroscopy of wide fields of view).

The committee recommended that the observatory's unique capabilities be available to the international astronomy community across the astronomical disciplines. It also recommended that the wavelength range be extended into the visible and MIR "if it can be done without a substantial increase in cost." The committee correctly noted that the process of goal-setting and design should be iterative and must continue through the mission's design phase. To perform the critical scientific portion of this process, the NGST Study Office, with the concurrence of OSS, appointed a Scientific Oversight Committee (SOC) to periodically review the progress of the studies from a scientific perspective and make its recommendations to NASA. At the same time, a volunteer NGST Science Working Group (SWG) began formulating the strawman science mission for NGST and simulating its performance. These efforts support the HST and Beyond Committee recommendations. We have chosen to describe these science drivers in terms of minimum performance requirements, the "science floor," and desired capabilities, "stretch goals" as shown in Table 3.1.

TABLE 3.1. NGST Goals: Performance Requirements and Desired Capabilities

	Science Floor	Stretch Goals
Aperture collecting area (m^2)	>12	>50
Wavelength (μm)	1–5	0.5–30
Imaging resolution (@1–2 μm)	0.050"	0.050"
Lifetime (years)	>5	10
Instrument capabilities	Wide FOV camera/spectrograph Zodi-limited background	Thermal IR camera/spectrograph coronagraph

Three Independent Concept Studies

In March 1996, GSFC formed the initial NGST study team made up of government, aerospace and academic experts. It tasked the group with studying and identifying feasible NGST mission concepts. Smaller groups, composed of experts covering all phases of mission development, formed “integrated product teams” (IPT) for the four major portions of the mission.

- The Optical Telescope Assembly (OTA) IPT studied the main telescope optics, including deployment, adjustment, and support structures.
- The Science Instrument Module (SI Module) IPT concentrated on the scientific instruments, including all optical adjustments following the OTA control, and all bore-sighted fine guidance sensors.
- The Space Support Module (SSM) IPT worked on all space support services: power, communications, propulsion, spacecraft computers and process control, thermal control, thermal shield, guidance, navigation, contamination control, and mechanisms.
- The Operations (OPS) IPT covered all ground activities responsible for the post-launch and routine science operations of NGST, including the communications antenna and ground station.

Each IPT, working with the mission system engineering group, began with an extensive list of required functions and explored the state-of-the-art and technologies that could provide them at acceptable cost and mass. With each level of potential solutions, the IPT would perform a trade study, listing the overall costs and benefits of a given approach. Often, two solutions were selected: one that was the best traditional method and another that was risky but capable of substantial reductions in cost or mass. In the latter case, a risk analysis and risk management plan were then developed.

Options considered in the trade studies included:

- Orbit (LEO, high Earth orbit [HEO], L2, solar drift at 1 AU, or deep space ellipse to 3 AU from the Sun, with or without gravity assists from flybys);
- Science implications of zodiacal light background in different orbits;
- Science implications of aperture size, temperature, and shape;
- Launch vehicle and shroud (Atlas IIAS, its successor the Atlas IIAR, Ariane V [if an ESA contribution were available], Proton [if it were permitted], various forms of the DoD-funded Evolved Expendable Launch Vehicle (EELV) and Shuttle;
- Astronaut assembly or assistance or backup in case of difficulty;
- Mirror design, materials choices, and deployment approaches;
- Sunshield design and deployment (number and shape of layers, structural versus deployed);

- Vibration and pointing control methods;
- Instrument design;
- Detector materials;
- Cooler design, including aggressive radiative coolers, sorption-pumped Joule-Thompson coolers, and Turbo Brayton and Stirling mechanical coolers.

This effort showed that many feasible combinations exist, each with an advantage and a cost. Deciding among them and the detailed mission design should be deferred until more detailed cost estimates are available and the scientific priorities become more mature. NASA could begin funding the development of technologies identified by the trade studies. But decisions regarding the final NGST configuration should await proposals from industry.

In May 1996, the NGST Study added two independent study teams led by TRW Inc. and Lockheed Martin Corp. The teams were selected competitively through a NASA-funded Cooperative Agreement Notice (CAN). These teams, like the GSFC-led team, were composed of experts from the aerospace industry, government laboratories, and universities. They worked to the same scientific and financial guidelines. Each developed a set of scientific drivers and conducted trade analyses culminating in the presentation of primary and secondary mission concepts on August 19–21, 1996. Altogether, the three independent teams covered a wide range of mission concepts, from a 16 m baseline, Y-shaped sparse array (MultiAp by Lockheed Martin) to the deployable segmented mirrors favored by TRW and GSFC. Several large monolithic mirror designs, including the primary Lockheed Martin concept, were predicated on the availability of large launch fairings (the enclosure that surrounds and protects the satellite during launch and ascent). The primary concepts from each team are described in Chapter 4, and the key technical elements are detailed in Chapters 5–9. The chapters are organized according to topic and the four IPT study areas.

Demonstrating Technical and Fiscal Feasibility

The results of the three studies demonstrate the technical feasibility of NGST. The mission does not require new inventions. Cost estimates for development and operations are equally critical elements of the three concept studies. Each team was allowed to use either parametric (cost modeling) or bottoms-up (cost of similar items) methods to estimate cost. For the GSFC-led concept, both methods reached consistent estimates, approximately \$546M for NGST development using full cost accounting methods. The results of the three studies are shown in

Figure 3.1. They have been divided into 10 separate cost categories, ranging from operations to the OTA. These estimates do not include management contingency, which would be ~25–30% for a program of NGST scale and complexity. Following the guidelines, all three study teams assumed that all technology development would be accomplished prior to the construction phase. As a result, these are optimistic cost estimates from the point of view of those familiar with other challenging programs such as HST or AXAF. Like NGST, these latter missions needed substantial technological advances in their telescope optics; but unlike the goal for NGST, they continued technology development during the manufacturing period. This practice results in redesign, wasted efforts, and prolonged manufacturing periods which all increase costs.

Breaking the Hubble Paradigm

Demonstrating cost feasibility for such a complex observatory is as daunting as proving technical feasibility. We surely can learn from HST and other mission experiences and not fall into the same cost traps. But HST and NGST are not commensurate. Table 3.2 illustrates some of the major differences in the two missions, differences which are described in the following chapters. Many of the infrastructure dependencies of HST are not relevant for NGST. Advances in materials and electronics in the last 20 years make HST appear

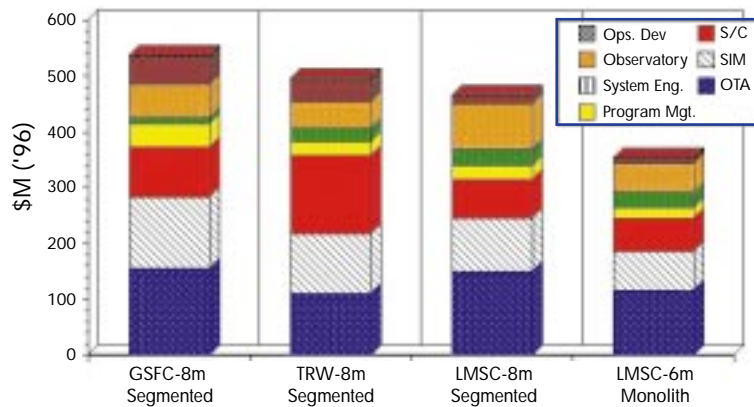

FIGURE 3.1. Manufacturing Cost Estimates for the Three Independent Studies. These estimates do not include predevelopment studies (Phase AB), technology development, and contingency (~30%). The three teams have allocated certain development costs to different cost elements. (NASA/GSFC)

almost antiquated. On the other hand, NGST uses ultralightweight optics and must deploy and operate at very low temperatures, temperatures comparable to the cryogenic temperatures of ISO and SIRTf. These are the chief technologies that must be developed before NGST construction should begin.

Strategies for Cost Containment

Our best strategies for cost containment are the use of new, paradigm-shifting technologies and the adoption of new ways of doing business that have already been used successfully in other recent development programs. The first strategic element ensures that NGST is developed with the most advanced, most cost-effective technology available.

TABLE 3.2. Comparison of HST and NGST

HST	NGST
Astronaut-rated and serviceable	Not serviceable, no astronaut safety issues
Shuttle launched, 11,000 kg	ELV launched, 3000 kg
Body pointed to <0.01"	Body pointed to 1" and fast steering mirror
Shared, distributed programmatic responsibility	Single prime contractor
UV/VIS/NIR space wavelengths	Optimized for near infrared
Superbly polished stable primary	Adjustable optics and wavefront sensing
Multiple science instruments	Single, integrated instrument
Paper and pencil engineering	CAD/CAM, concurrent engineering via internet
Complex, frequent commanding	High levels of autonomy
South Atlantic Anomaly pass each orbit	Outside radiation belts
Long integration and test; challenger delay	Four year development
Contamination concern high for UV	Contamination concern low for IR
Eclipses each orbit	Stable thermal environment
Complex communications using NASA's geosynchronous satellites	Single dedicated ground station
Ground telescope taken to space	Ultralightweight telescope designed for space
Limited phases A/B	Extended phase A/B with technology development
No precursor flight tests	Two to three precursor flight tests
Diffuse system engineering	Systems group at prime is responsible
Classified technology for primary	DOD technology becoming public

For example, all three NGST concepts use on-orbit wavefront adjustment of the primary mirror assembly. This will significantly reduce or eliminate the cost and schedule burden associated with elaborate optical figuring and polishing to severe optical tolerances. On the recent AXAF Program and for HST, the figuring process for the mirrors cost \$200–250M (96).

The aggressive use of timely technology is essential for producing the lowest-cost telescope that meets our science requirements. The chief problem with this approach is the difficulty of accurately predicting future construction costs. We will reduce these uncertainties using a series of ground testbed and flight experiments. For NGST, we have included several precursor flight experiments or pathfinders, in the early mission-development period (Phase AB, see below). These pathfinders increase in sophistication and resemblance to a full-up NGST observatory. With each flight experiment, we validate our choice of technologies, improve our abilities to predict scientific performance, and improve our estimates for construction costs.

Recent NASA experience with the Mars exploration, SMEX and Discovery missions suggests that we can contain cost growth by prohibiting ever increasing science requirements and establishing firm cost limits at the outset. This is why we have established the science floor and stretch goals. The stretch goals are pursued only if they do not significantly increase costs. For example, in the area of wavelength coverage, we will design the optical system for near-perfect performance for $\lambda=1-2 \mu\text{m}$ and accept whatever performance we obtain at shorter wavelengths. We anticipate that each new mission architecture will be developed around the core science mission but permit ample opportunity to use NGST for other scientific goals. In addition, we must continue to study a wide range of mission options, including those that are less risky and consequently less costly. We describe one such mission, the 5–6 m NGST δ , in Appendix D. It is compatible with a Delta II launcher and would accomplish many, but not all, of the goals of the HST and Beyond recommendation. Like the three mission concepts, it requires significant technology development. Studies of the NGST δ and other concepts will help provide the proper context for NASA decisions in the crucial 2000–2002 time frame.

Several of the following technical chapters address the use of new industry standards and design practices to reduce cost. Regarding management, we must look to higher-level changes in the way NASA does business. We have already made great strides by integrating government, industry and academic experts in the three concept studies and ensuing program. Our goal is to establish long-term industry partners and provide a stable base of support for NGST-related technology development. Our long-term vision is that a prime contractor will be

responsible for all phases of the NGST construction. Through partnerships and access to the enormous technical resources of a major aerospace firm, managers, engineers and scientists will strive to provide the best mission for the money. Contract fees based upon on-orbit performance and a streamlined, almost paperless design process promise to reduce overall costs significantly. To make this vision real, we must establish good working relationships and trust among all the stakeholders in NGST: science community, NASA and industry.

The Roadmap to Mission Readiness

The NGST Study team, the SOC and the Origins External Review Board (OERB) have identified technology development as the critical issue for NGST. Like the other ambitious missions in the Origins initiative, the Space Interferometer Mission (SIM) and the Terrestrial Planet Finder (TPF), the NGST program will use new technologies that enable new science and reduce costs. Mission readiness will be determined as much by progress in mission-specific industrial capabilities as by fiscal constraints.

Immediately following the Concepts Briefing in August 1996, select members of the three concept-development teams participated in a technology roadmap workshop sponsored by the NGST Study Office. The goal of this workshop was to identify, make a list of priorities, and establish technical performance metrics for the NGST enabling technologies — those industrial capabilities that must be established before development of NGST can begin. The resulting plan, including the logical progression and interrelationships among these developing technologies, is called the NGST Technology Development Roadmap. We describe the development plan in Chapter 10 and depict the flow of additional concept studies and technology-development efforts as well as the pathfinder missions in Fig 3.2. Just as the mission concepts will evolve, we will continue to revise and improve the roadmap for NGST technology development. This will happen as we improve our understanding of the NGST science mission, the capabilities of the aerospace industry, and the results of focused NGST and other NASA-sponsored research.

The NGST Mission Plan: Reaching the Goal at an Affordable Cost

It is never too early to plan. A proper plan provides context for the current effort and includes the strategy for success. Some of our planning is provided by our charter — a launch as early as 2005. We derive

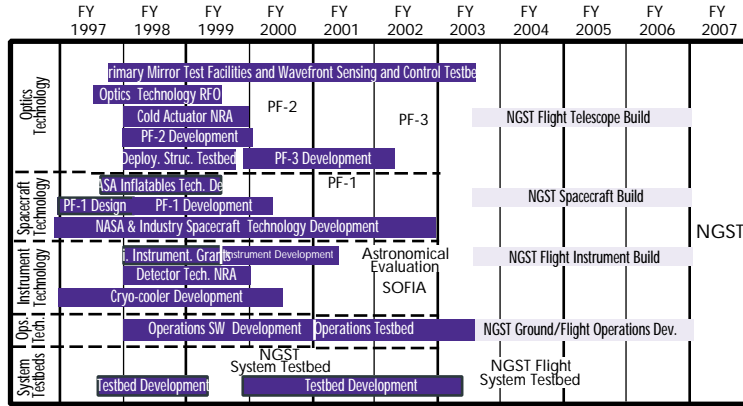

FIGURE 3.2 The NGST Technology Roadmap Leads to Mission Readiness in 2001. (NASA/GSFC)

other parts from the three study estimates for construction times and nominal procurement cycles. Most importantly, the plan accommodates further mission definition, technology development, the pathfinder missions and a series of tests and decision points that will lead to mission readiness by 2001. The NGST Mission Plan is shown in Figure 3.3. We describe the roles of NASA, academia, and industry in relation to the plan below. Each has critical roles throughout the life of the program.

- NASA: The space agency is responsible for the highest-level management of the NGST Project. In the early study period, through Phase A, NASA will fund further studies of NGST mission concepts, technology development and science mission goals. It also will organize Annual Technology Challenge Reviews to encourage communication and healthy technical competition within the aerospace industry. To support the critical Preliminary Non-Advocate Review (PNAR) and to develop deep technical understanding of the key technical areas, NASA also will undertake in-house system analyses and mission studies. NASA will develop some of the NGST testbeds and the early pathfinder missions. NASA will hold the Non-Advocate Review and Preliminary Design Review before the selection of the prime contractor (Phase BCD). After this period, the responsibility for developing NGST will fall to the prime contractor. NASA will become a technical partner, assuming responsibility for engaging the scientific community and monitoring compliance with government contracting and regulations.
- The Scientific Community: Through Phase A, the scientific community will work with NASA through the SOC and an interim Science Working Group. The latter group will refine the Design Reference

Mission, study the scientific capabilities of the observatory, and analyze new mission concepts. Some universities will be key participants in NGST technology development, particularly in the areas of optics and science instruments. Just prior to the PNAR, the mission SWG will be selected competitively to work with NASA and the prime contractor on the final definition of the observatory and scientific instruments. That team will define and undertake the initial NGST science program. Annual scientific workshops and national and international meetings will provide a forum for discussing the goals and capabilities of NGST throughout the study and construction periods.

- **Industry:** Most of the technology development and all of the observatory construction and operation will be done by industry. Two industry teams will be chosen to develop NGST mission concepts and related technology in Pre-Phase A and Phase A. Other industries will engage in NASA-directed technology development: actuators, lightweight mirror fabrication, etc. Industry will develop proprietary testbeds prior to selection of the prime contractor. Beginning in Phase B, the prime contractor will develop near full-scale NGST testbeds and any mission-critical pathfinder missions. After construction is begun, the prime contractor will be responsible for managing the construction, testing and launch of the NGST. The company or institution responsible for science operations will work closely with the prime contractor during the construction phase and in the engineering period following launch.

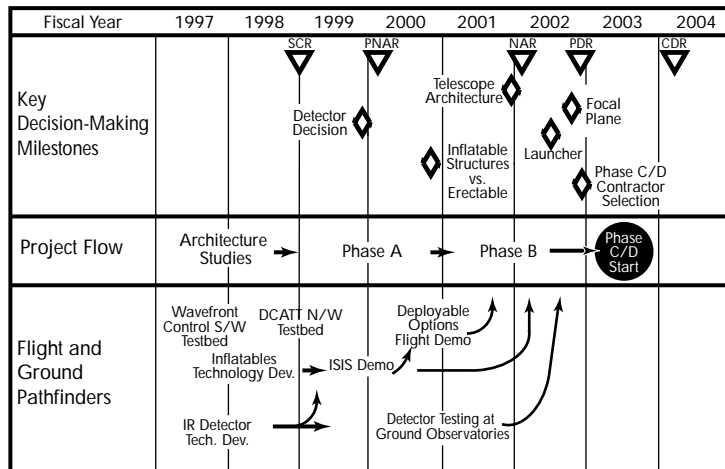

FIGURE 3.3. The NGST Mission Plan. (NASA/GSFC)

CHAPTER 4

Concepts for the Next Generation Space Telescope

THE GSFC-LED NGST STUDY and the two independent study teams presented the results of their concept studies on 19–21 August, 1996. Each team summarized its view of the scientific rationale for the NGST mission and the preferred approach. The printed publications, which consisted of annotated viewgraphs, ran 200 to 500 pages per team. In this chapter, therefore, we provide thumbnail sketches of the three recommended concepts, in the order in which they were presented. We have two goals: to provide the appropriate context for the technical chapters that follow, and to highlight the technical philosophy behind each concept. All three concepts provide scientific capabilities that meet or surpass those envisioned by the HST and Beyond Committee.

The Lockheed Martin-Led Study Concept

A broad range of design solutions, including systems with large monolithic telescopes, deployable telescopes, and partially filled telescope arrays, are feasible and would satisfy the NGST science requirements. The Lockheed Martin design team evaluated the entire NGST mission with the goal of maximizing sensitivity in the NIR while minimizing complexity. As a counterpoint to the deployable telescope systems recommended by the other two teams (see below), the Lockheed Martin team focused on the 6 m monolithic telescope system pictured in Figure 4.1. This size telescope was estimated to be the largest that can be launched as a single, non-deployable system. The team showed that, with good detectors, dark current $<0.05 \text{ e s}^{-1}$, the 6 m telescope in either a 1–3 AU elliptical heliocentric orbit in the ecliptic plane or a 1 AU circular heliocentric orbit inclined to the ecliptic plane is as sensitive in broad band imaging and low-resolution spectroscopy as a larger telescope at L2.

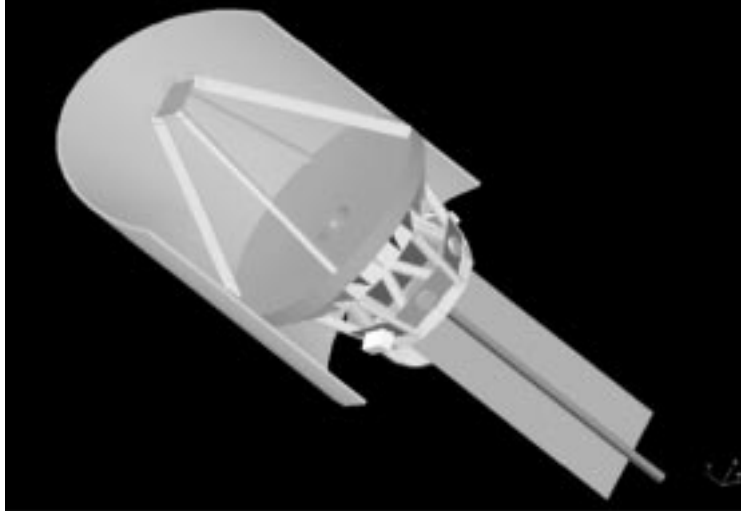

FIGURE 4.1. Lockheed Martin 6 m aperture monolithic telescope. The large solar arrays are deployed well to the rear of the telescope to reduce heating effects. (Lockheed Martin)

The 6 m monolith design requires a large launch fairing (protective enclosure) — larger in diameter than is now commercially available. However, the manufacturers of several launch vehicles, including the Atlas IIAR, H II, Ariane V and Proton, indicate that their vehicles' performances are compatible with the ~7 m fairing needed to encapsulate a 6 m monolithic telescope. Current vehicle designs or planned improvements can accommodate the more demanding structure and control requirements. The increased fairing mass and drag also exacts performance penalties in lift capacity. One supplier, Lockheed Martin Astronautics, developer of the Atlas IIAR, estimates the penalty for its vehicle at less than 400 kg, depending on the selected trajectory. Analysis of innovative trajectories involving gravity-assist maneuvers with the Moon and the Earth indicates that these penalties could be overcome and that all of the candidate orbits are achievable with an 1800 kg spacecraft.

To achieve the minimum spacecraft complexity, the Lockheed Martin team selected a deeply figured ($f/1$) Ritchey-Chretien two-mirror design. The secondary mirror and its support fit within the launch fairing and do not deploy. To use the strongly curved focal plane, Jim Gunn (Princeton) proposed a bowl of relay optics behind the primary mirror to send portions of the field to a set of distributed instruments for science data acquisition and guiding. A key aspect of these optics is rapid tip/tilt mirrors at pupil images in the optical path to each instrument. These tip/tilt mirrors

are controlled in a master/slave fashion to the master fast-steering mirror. This arrangement increases the potential FOV of the telescope and minimizes the size of the master fast-steering mirror. The Lockheed Martin design includes the full complement of scientific instrumentation and provides an option for MIR science.

The 6 m monolithic primary mirror may have a variety of potential designs. The Lockheed Martin study highlights the use of a 2 mm thick glass membrane supported on a set of 2,700 actuators fixed to a stiff carbon fiber support structure (areal density $\sim 20 \text{ kg m}^{-2}$). As in the segmented designs, a redundant set of actuators adjusts the figure of the thin glass primary on time scales longer than a typical observation. Similar to the other two concepts, the secondary mirror in the Lockheed Martin concept is lightweight, optically stiff and has 6 degrees of freedom (d.o.f.) for focus and alignment. Because the primary mirror and secondary mirror are not deployed, their support structure is extremely stiff. The Lockheed Martin telescope has the lowest structural mode frequency of 20 Hz (due to a torsional resonance of the secondary tower), a value much larger (better) than the $\sim 1\text{--}2$ Hz typical of the deployable 8 m designs.

The Lockheed Martin concept uses a state-of-the-art spacecraft support module or “bus” to achieve a total bus mass of under 500 kg, with power

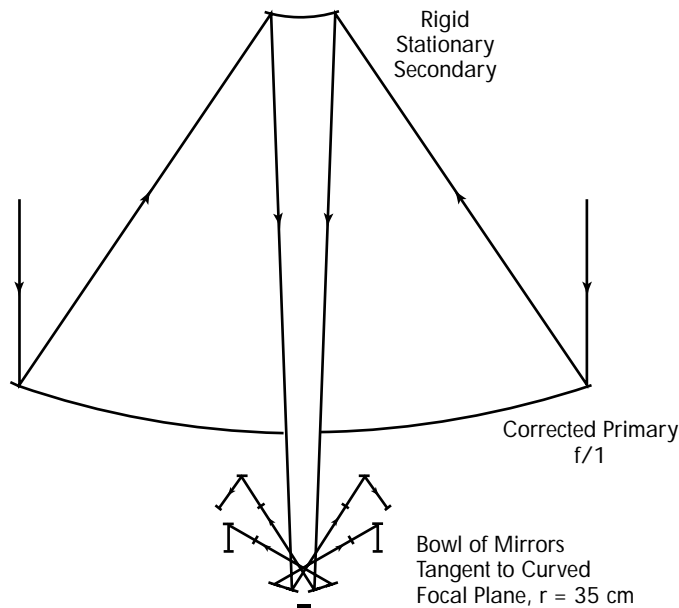

FIGURE 4.2. Lockheed Martin NGST optical design. Designed by Jim Gunn (Princeton), a bowl of relay optics send portions of the curved field to specialized instruments. (Lockheed Martin)

consumption under 200 W. Bus components circle the large volume behind the primary mirror and radiate their heat away from the telescope. For the non-deployed, monolithic design, the structures, mechanisms and pointing control are straightforward and simpler than those in a deployable system. For the 1 x 3 AU orbit, the power and communication subsystems are more complex. However, these technologies are well within the current state of the art and are not the driving aspects of the Lockheed Martin NGST concept.

The TRW-Led Study Concept

The TRW design team elected to study a large deployable system, an area in which they have considerable experience. Figure 4.3 illustrates TRW's NGST in its operational orbit around the L2 point. Shaded by a deployable silver Teflon sunshield and four aluminized mylar sheets, the 8 m telescope and scientific instruments are radiatively cooled to 30 K. The gold-coated primary mirror consists of six hexagonal petals that are deployed after launch to form a ring around the fixed central petal. The secondary mirror is supported by three deployable struts, which also fold to fit within the fairing of an Atlas IIAR.

Key design features are shown in Figure 4.4. The spacecraft bus is in the center of the symmetric sunshields. Like the GSFC design (below),

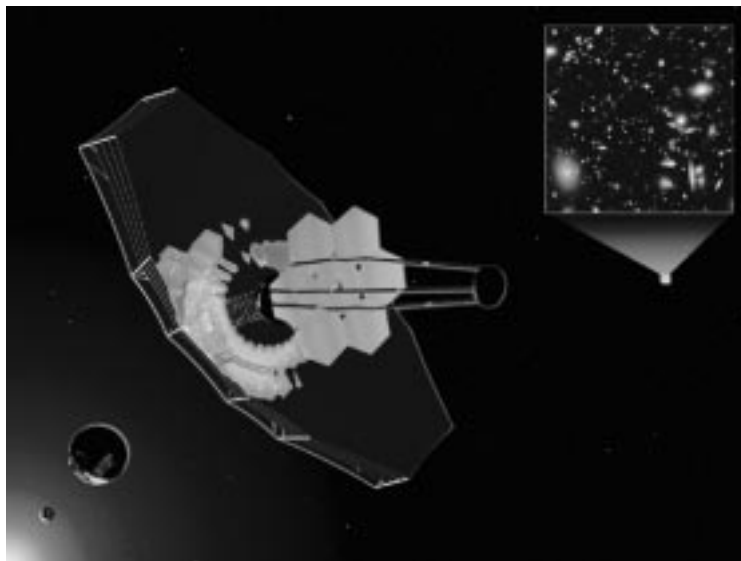

FIGURE 4.3. The TRW NGST in its operational orbit near L2. The artist has added a light source to view the shadowed telescope. The inset of a deep sky image is the same as that on the cover. (TRW)

the shield geometry balances the radiation pressure torque from sunlight. However, the TRW concept includes variable reflectivity, “electrochromic” patches on the sunshield to yield solar torques to unload the attitude control system momentum wheels. The solar shield also has thin-film, amorphous-Si solar arrays, which supplement the GaAs solar arrays on the body of the spacecraft. Three propulsion systems are used (see Chapter 8): bipropellant for transfer-orbit maneuvers, monopropellant for attitude control during transfer orbit and (non-contaminating) hydrogen resistojets for station keeping after the spacecraft is at the L2 point and fully deployed.

The TRW NGST is designed to observe objects anywhere in the anti-solar hemisphere and to track solar system objects for several minutes at a time. The 6 m deployable mast isolates the warm bus from the science instrument module and includes a gimbal. This varies the angle between the sunline and the optical axis from 90° to 180° (anti-Sun). Like the other two concepts, coarse telescope pointing involves rotating the spacecraft (in azimuth) about the sunline and nodding the spacecraft ±10° (in elevation) with respect to the sunline.

The primary mirror is a relatively fast (f/1.25) Ritchey-Chretien, with segments that are adjusted in tip, tilt and piston (focus), as well as some shape control. The deployment mechanisms and latches for the seven hexagon-shaped petals are similar to those in the High Accuracy

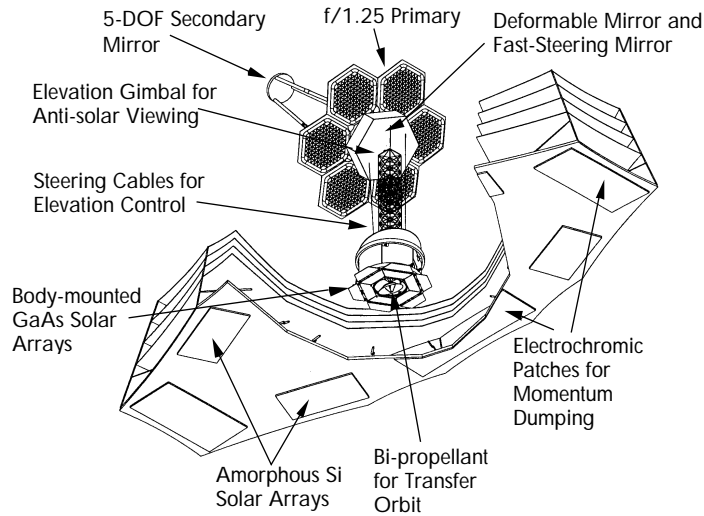

FIGURE 4.4 . TRW NGST Design Features. The symmetric lightshield aligns the center of radiation pressure on the center of mass in order to minimize radiation torque. (TRW)

Reflector Development program (HARD) for 60 GHz space antennas. The secondary mirror is an 80 cm, optically stiff monolith in a 5 d.o.f. mount. The two mirror combination is $f/15$. Relay optics below the primary mirror vertex include a deformable mirror for additional wavefront corrections and fast-steering mirrors for fine guidance. The diameter of the FOV is 10' and is divided into two square 2.64' x 2.64' science camera apertures near the center of field, two 1' x 0.1' slit spectrometers and three 2' x 2' regions for the fine guidance cameras. Each science camera and spectrometer path contains a dichroic filter that transmits long wavelength light to one instrument and reflects short wavelength light to another. The four spectral bands are: 0.5–1.0 μm , 1.0–2.5 μm , 2.5–5.0 μm and 5.0–12.0 μm . The ability to observe two spectral regions simultaneously over the full field of view is a key design advantage of the TRW instrument design. The entire wavelength region extends beyond the NIR core wavelength coverage but does not require active cryogenic cooling. Longer-wavelength instruments and active cooling are an option.

The GSFC-Led Study Concept

The GSFC IPTs studied concepts that met NGST science requirements within the allowable costs and made use of available launch vehicles (Atlas IIAR). To reduce financial and technical risks, the teams favored simple solutions and used promising technologies that would not require large research programs. The choice of orbit, described in the following chapter, has a profound effect on the rest of the design. The L2 orbit provides easy communications; and the Atlas IIAR can place almost three times the spacecraft mass into L2 compared with a 1 x 3 AU orbit. But the 3 AU orbit offers a dramatically lower zodiacal background. While an L2 mission is technically simpler, science was actually the deciding factor. For low- and moderate-resolution spectroscopy, where detector noise can equal or exceed the zodiacal background, telescope collecting area is most important. An 8 m telescope at L2 is superior to a significantly smaller telescope at 3 AU for NIR spectroscopy, a critical and time-consuming component of the study of early galaxies.

Like the TRW design, the GSFC concept uses deployable, lightweight structures: an inflatable, multilayer sunshade, a nine-segment primary mirror, an extended, secondary mirror support structure, and a mast separating the spacecraft from the science instrument module. As shown in Figure 4.5, these structures fit inside the Atlas IIAR Extended Payload Fairing (EPF). The structures deploy as the satellite travels to its operational L2 halo orbit along a direct-injection trajectory and after separating from the Centaur upper stage (Figure 4.6). This approach keeps the

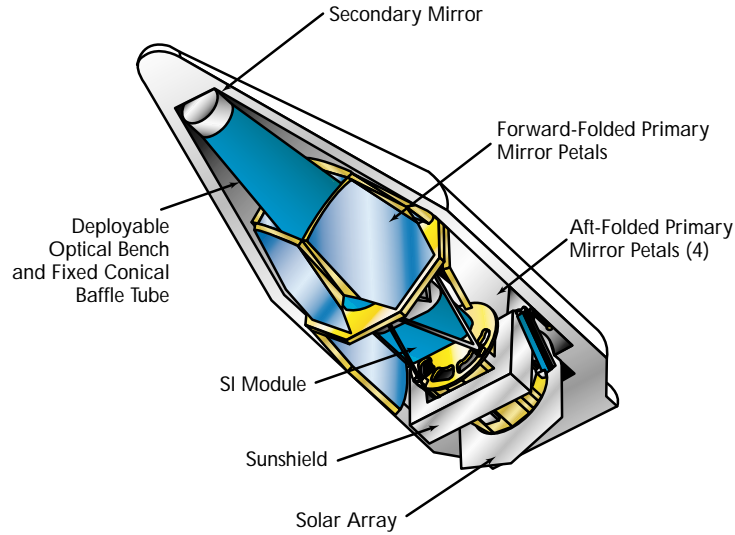

FIGURE 4.5. The GSFC NGST Fits Inside an Atlas IIAR Fairing. The eight optical segments hinge up and down to fit inside the fairing. The secondary mirror structure extends from the central light baffle. (NASA/GSFC)

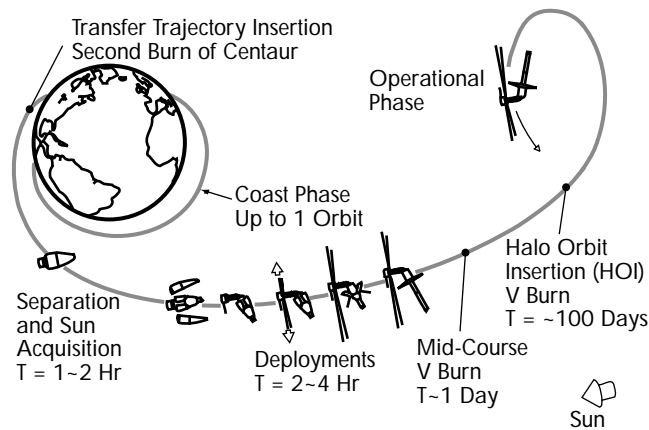

FIGURE 4.6. The Deployment of the GSFC NGST during Its Trajectory to L2. The optics and sunshield are deployed only 2-4 hours after launch and begin to cool to their operational temperatures. (NASA/GSFC)

spacecraft in full sunlight and eliminates the need for heavy storage batteries. However, it requires additional attention to possible molecular contamination.

Aside from the details of secondary deployment and the relative merits of independent and serial deployment of the primary mirror petals, the designs of the two optical systems (GSFC and TRW) are similar. Both telescope designs provide an adequate FOV, which the GSFC SI Module IPT chose to devote primarily to wide field imaging and multi-object spectroscopy. A MIR capability with high performance Si:As detectors is explicitly part of the GSFC instrument complement, even though it requires active cooling with a Brayton cycle cooler.

The GSFC spacecraft and support structures are simpler than those in the TRW design. The GSFC concept does not include a gimballed OTA, but cants the telescope axis by 25° to the plane of the sunshield, to achieve good access to low-background regions on the celestial sphere (Figure 2.4). Likewise, a phased-array, high-gain antenna does not require gimbals. Rather than separate systems, a single bipropellant system is used for orbit transfer, station keeping at L2, and offsetting radiation torque buildup. The deployed GSFC concept and the separate OTA, SI Module and SSM segments are shown in Figure 4.7.

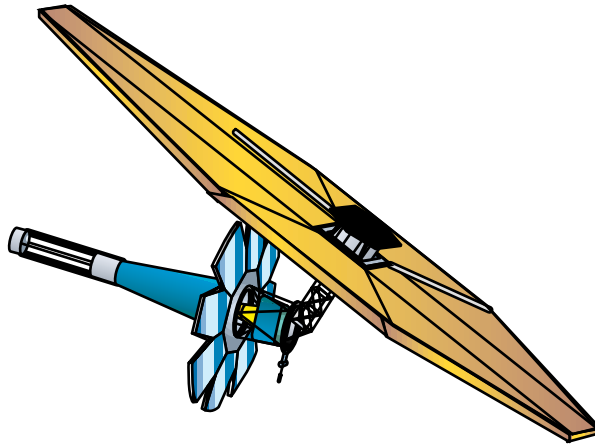

FIGURE 4.7. The GSFC Concept for an 8m NGST. The primary mirror is made of eight deployed segments surrounding a central mirror element. Like the TRW design, the telescope uses a symmetric sunshield and a thermally insulating truss or mast. (NASA/GSFC)

CHAPTER 5

Launch and Orbit

GETTING TO SPACE is the essence of space science and the NGST. Most astronomical satellites have been placed into LEO, where they enjoy the perfect transparency of space and cosmic-ray shielding by the Earth's magnetic field. Near-equatorial LEO provides the best shielding and easiest access. Sun-synchronous polar LEO yields steady solar power and a restricted view of the celestial sphere which is not occulted by the Earth. Higher orbits, which are much more expensive to reach, can have significant advantages. The International Ultraviolet Explorer (IUE) used a geosynchronous Earth orbit (GEO) similar to that of a communications satellite. As a result, IUE could be operated by both European and US ground stations. The SOHO mission, which studies the Sun, is near the inner Lagrangian point, L1, 1.5 million km from Earth toward the Sun. There it has an unimpeded view of the Sun's surface and corona. Since our choice for the NGST orbit has far reaching consequences for the mission, it should be reexamined at several stages during the life of the project.

The choice of orbit is strongly tied to the choice of the launch system, its cost and performance. Even with the advances of over a half a century of rocketry, the current and foreseeable launch vehicles place substantial financial and physical constraints on the entire mission design. With the same amount of propellant, lower orbits can be reached with much more massive payloads. To place a payload into an L2 orbit, for instance, we need approximately 100 times the payload weight in fuel and sophisticated engines, structures, and staging systems. The payload weight for a 1 x 3 AU orbit is approximately three times lower than that for an L2 orbit. Moreover, the high cost and risk of developing new launch systems result in a limited menu of launch/orbit options. For lightweight, low-density payloads, such as NGST, the available fairing dimensions are also critical. We must design the telescope to fit the launch vehicle performance, lift capability and fairing dimensions. The launch cost must also be consistent with the overall cost of the mission development. While we may consider the

concept of launching a less sophisticated and less expensive NGST (i.e. a simple, heavy telescope) with a more expensive launcher, this is a choice seldom made and one not pursued in our studies.

At this stage in the NGST study, our ground rules are to consider U.S. launch vehicles only. However, the Lockheed Martin study explicitly considered a wider range of options; and we include these possibilities in this chapter. Our overall criteria are cost and compatibility with the science mission described in Chapter 1. In this chapter we present the primary orbit options and the performance of current and projected launch vehicles in the context of the three independent concept studies.

Low Earth and Geosynchronous Orbits

All three study teams choose orbits that are far from the Earth. Although the LEO weight-to-orbit performance is much greater for all launch systems, the NGST concept does not work in the LEO environment. Probably the worst difficulty with LEO is the thermal heating of the cold telescope optics by the warm Earth. We could employ adequate thermal and straylight shielding for a telescope that never viewed the warm Earth in Sun synchronous LEO; but such a telescope will have very limited access to the celestial sphere. Sun synchronous orbits can be a good choice for all-sky survey telescopes such as IRAS, but they are a poor choice for deep imaging and follow-up spectroscopy. Large telescopes in LEO must also deal with large disturbances due to gravity and the residual atmosphere. Like HST, such telescopes must be stiffened by heavy support structures and strong active pointing control. Atmospheric drag at shuttle altitudes (500 km) is significant for low density missions (large surface areas and low mass). NASA uses periodic space shuttle visits to boost HST to higher altitudes to avoid re-entry during periods of strong solar activity and greater atmospheric drag. Clearly, we can not afford to make a larger HST that was designed to cope with all these issues.

GEO and elliptical HEO have the advantage that they are far from the Earth, where the average heating of the NGST optics is reduced. Because of trapped particles in the Van Allen belts, both orbits have periods of high, potentially damaging particle backgrounds. Moreover, the thermal and pointing disturbances near perigee (nearest approach to Earth) are severe in HEO orbits. Furthermore, the relatively small difference in launch performance between these high Earth orbits and the L2 and solar orbits suggests that neither GEO or HEO are appropriate.

The L2 Libration Point

In the Sun-Earth gravitational system, there are 5 Lagrangian or libration points (see Figure 5.1). Two (L4 and L5) are stable and three are metastable, i.e. a spacecraft will not return to the libration point if it is perturbed. Of course, the universe is full of perturbing forces, namely solar pressure and other planetary bodies. Nevertheless, we can maintain a spacecraft's orbit around the metastable libration points by performing periodic station-keeping maneuvers. In essence, the spacecraft orbits the libration point rather than a celestial body. For NGST, the best candidate orbit is the metastable L2 libration point — one of the collinear libration points located on the anti-Sun side of the Earth, 1.5 million km away.

The L2 libration point is ideal for astronomical viewing, since the Sun, Earth, and Moon are always on one side of the telescope. A single shield can eliminate straylight from the Sun and, with some scheduling constraints, from the Earth and Moon. Secondly, the constant distance from the Sun (1 AU) provides a stable thermal environment with continuous solar illumination for generating on-board power. Finally, radio communications with 1 MHz bandwidths can bridge the 1.5 million km distance without resorting to very large ground antennae or to powerful spacecraft transmitters. Past and future science missions (ISEE-3, WIND, SOHO, and ACE) have used a libration point orbiter as an excellent platform for space science.

There are three ways to get to L2 (Figure 5.2). Two methods obtain additional performance via a lunar swingby (a gravitational bank-shot).

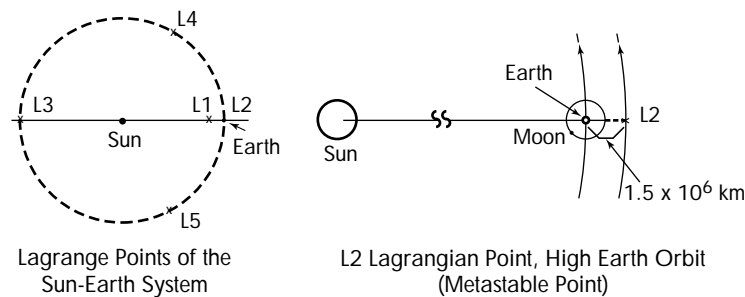

FIGURE 5.1. Lagrangian Points. The NGST may use the L2 Lagrange point, about 1.5×10^6 km from the Earth. (Lockheed Martin/STScI)

In one of these, the launch vehicle sends the spacecraft on a direct trajectory to the lunar swingby. In the second option, the launch vehicle places the spacecraft into a HEO with its apogee at lunar distance. The spacecraft executes several orbits until it passes by the Moon and receives the necessary gravitational energy to continue its voyage to L2. The lunar swingby methods offer two distinct advantages. Careful control of the altitude and orientation of the lunar approach can eliminate the final L2 insertion maneuver. Furthermore, the launch energy needed for the lunar swingby is the least of the primary orbit options. There are some drawbacks. First and foremost, the Moon must be in the correct location when NGST makes its closest approach or the spacecraft's trajectory will not be bent sufficiently to send it to L2. Coordinating the launch with the Moon's orbit severely restricts the monthly launch window. For the direct lunar swingby, the launch window is limited to 1 day per month. Additional months spent waiting for launch bring high labor costs and handling risks. Using phasing loops will increase the launch window to 7–14 days per month but require additional maneuvers to correct for launch "dispersions" (trajectory errors). Furthermore, the spacecraft must be designed to be safe during the repeated near-Earth perigee passes and occultations. The direct insertion method for reaching L2 is accomplished by using slightly more launch vehicle energy and avoiding the Moon entirely. This method also requires a maneuver to complete the insertion into the L2 orbit. The major advantages to the direct insertion are its simplicity and the wide launch window (27 days per month).

1 AU Drift-Away Orbit

The SIRTf will use a "drift-away" orbit (Figure 5.3) and will enjoy the same scientific advantages as those for the L2 orbit. The orbit perihelion is the same as the Earth's and the aphelion is slightly larger. As

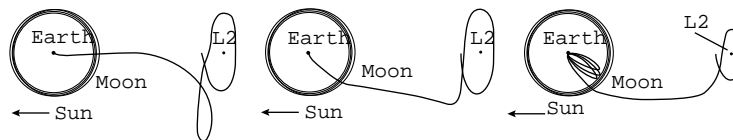

FIGURE 5.2. Three ways to get to L2. The three panels show a direct insertion (no help by the Moon), a direct lunar swingby, and using phasing loops to wait for the Moon. (Lockheed Martin/STScI)

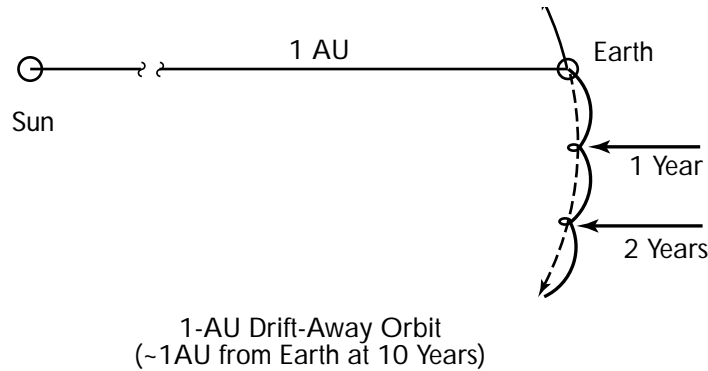

FIGURE 5.3. Drift-Away Orbit. By just escaping the Earth's pull, a spacecraft can slowly drift away at a minimum rate of 0.1 AU yr^{-1} . Each year, the distance to the Earth increases and the radio communications rate declines. (Lockheed Martin/STScI)

a result, the spacecraft slowly lags the Earth in its orbit and drifts away as both orbit around the Sun. To reach a drift-away orbit, the launch vehicle must provide enough energy to escape the Earth's influence. The orbit provides the same stable thermal and power environment as the L2 orbit. The major advantage of the drift-away orbit is that the propulsion system can be minimized, perhaps even eliminated if the launch vehicle dispersions are small. The principal drawback is maintaining the communications link. With the minimum drift rate of 0.1 AU per year, the NGST would eventually be 0.5 to 1.0 AU (75 – 150 million km) from the Earth for a 5 to 10 year mission. These distances are comparable to those for the $1 \times 3 \text{ AU}$ orbit and will require the Deep Space Network (DSN) or laser communications for 0.1 – 1 MHz data rates.

Heliocentric $1 \times 3 \text{ AU}$ Orbit

Orbits far from the Sun can provide a much lower zodiacal light background. As we show in Chapter 2, the trade-off in NGST sensitivity is such that a 6 m telescope at 3 AU from the Sun has comparable or superior performance to an 8 m telescope at L2. The Lockheed Martin study team chose a $1 \times 3 \text{ AU}$ elliptical orbit (1 AU at perihelion and 3 AU aphelion) with a 2.83 year period to take advantage of the low background. The chief technical advantage is the relative simplicity of using a 6m monolithic mirror, a fixed secondary structure, and a fixed sunshield. Since this simplicity also translates to a lower weight, the

Lockheed Martin study concluded that a 6 m telescope could be sent to 3 AU with launchers available to international partners or the next generation of US launchers. Other ways to achieve a 1 x 3 AU orbit include possible swingby orbits with the Earth, Moon, and Venus. The Galileo spacecraft reached Jupiter after a prolonged voyage through the inner solar system picking up energy through such maneuvers. However, there are several other drawbacks to the 3 AU orbit related to its distance from the Earth and Sun. Near aphelion, the distance from the Earth can be as great as 4 AU. High bandwidth communications would require optical communications or a large, steerable antenna as well as a powerful radio transmitter on NGST and use of the DSN. To power the radio transmitter and the rest of the spacecraft electronics, NGST would need large solar arrays that can deliver the required power at 3 AU and be electrically reduced or trimmed as the solar distance and power change during the orbit.

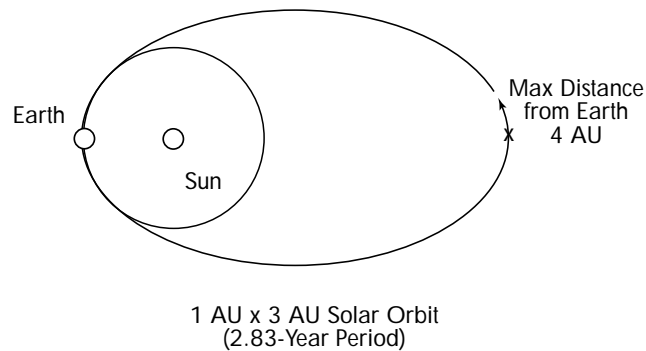

FIGURE 5.4. Heliocentric 1 x 3 AU Orbit. (Lockheed Martin/STScI)

Astronaut Involvement

The highly successful Shuttle servicing missions of HST in 1993 and 1997 illustrated how astronauts can refurbish and maintain a sophisticated science satellite. In 1997, astronauts inserted two new state-of-the-art instruments in HST, thereby lengthening its scientific lifetime. The GSFC study considered the involvement of astronauts in the launch, deployment, and servicing of NGST. The space shuttle's large payload bay and heavy-lift capability might be used to place NGST into LEO either for astronaut assembly or astronaut assistance with deployment. From LEO, an upper stage could be used to inject NGST into one of the three solar orbits. There were three major drawbacks with this concept. First, we were concerned with the safety of bringing or rendezvousing with a large upper stage, particularly if astronauts are used to attach the deployed NGST to the upper stage. Second, the NGST must either be compatible with operations and survival at both LEO and L2 or it must be constructed in a protective shelter in LEO. Third, the cost of shuttle operations and safety engineering appears to outweigh the potential advantages of astronaut involvement. Bringing the NGST back from L2 to LEO for periodic maintenance is even more expensive. Not only must the safety of shuttle and LEO operations be considered, but we must use valuable payload weight for the return retrorocket. All three study teams concluded that expendable launch vehicles (ELV) provide the safest, most cost-effective options for achieving the mission orbit.

Launch Vehicles: A Limited Menu

To evaluate the launch vehicles, we must understand how much launch energy is required to deliver NGST to the desired orbit. The nominal figure of merit is the C_3 launch energy (km^2/s^2). The C_3 energy is measured with respect to the energy required to escape the Earth's gravitational "well." With $C_3 < 0$, a spacecraft is bound to the Earth. On the other hand, with $C_3 > 0$, the spacecraft is no longer bound by the Earth and is considered to orbit about the Sun. Using the C_3 required for the candidate orbits and launch vehicle performance curves, we can calculate the maximum separation mass that the launch vehicle can deliver. Table 5.1 indicates the performance of both US and international launchers.

TABLE 5.1. Launch Vehicle Performance. Maximum Payload Masses (kg) to the Three Primary Orbit Options

Candidate Orbit	Lunar Swingby to L2	L2 Direct	Drift-Away	1 x 3 AU
C_3 Energy (km^2/s^2)	(-2.24)	(-0.69)	(0.40)	(45)
Atlas IIAS	2820	2567	2650	940
Atlas IIARS	3300	3200	3140	1250
Delta 7925-10L	-	1280	-	424
Delta III	2860	2762	2750	1170
Sea Launch	-	3300	-	<300
Titan IV	7270	-	-	2424
EELV-Medium	3670	-	3450	1310
Ariane V (France)	6200	-	5800	1980
Proton (Russia)	4910	-	4760	1690
H II (Japan)	2800	-	2910	1070

The other primary factors in selecting launch vehicles are the cost and the dimensions of the largest available fairings. These are shown in Table 5.2. The approximate costs are for basic launch services only. Actual launch system costs for the NGST program may differ significantly depending on the need for additional integration activities or foreign launch agreements. The Lockheed Martin study found that several manufacturers are confident that larger shroud dimensions can be accommodated with some loss in performance. The data from these two tables are consistent with the choice of the Atlas IIARS for the two deployable mission concepts which use U.S. launchers and the Proton or Ariane V launcher for the 1 x 3 AU mission concept. If the NGST Project were an international partnership with one of these countries (ESA, Russia, and/or Japan), the latter three launchers could provide comparable or superior launch capabilities to the Atlas IIARS.

TABLE 5.2. The Cost and Maximum Fairing Dimensions of Major Launch Vehicles

Launch Vehicle	Approximate Cost ('96 M\$)	Max. Payload Diameter (m)	Max. Height at Centerline (m)
Atlas IIAS	110	3.65	9.74
Atlas IIARS	100	3.65	9.74
Delta 7925-10L	75	2.74	5.40
Delta III	85	3.75	8.89
Sea Launch	60	3.75	8.54
Titan IV	450	4.60	17.00
EELV MLV-A	80	3.95	9.74
Ariane V (France)	150	4.57	10.35
Proton (Russia)	65	4.35	7.90
H II (Japan)	190	4.60	9.19

CHAPTER 6

Large Space Telescopes: An Issue of Transportation

WHAT HAS REALLY BEEN LIMITING the size of optical telescopes? The answer, about fifty years ago, would have been “roads.” The road up Mt. Palomar was more costly and challenging than the construction of the telescope itself. With the advent of space astronomy, the road to space (the launcher performance and fairing dimensions) became the limiting factor. The industrial and academic optics communities have solved the problems of making monolithic mirrors as large as 8.3 m in diameter for ground-based applications. This is about the largest size that can be transported overland in the USA. Even this paradigm has been broken with the Keck telescopes, whose 10 m mirrors are built in smaller segments, transported to the site and assembled on a supporting backing structure. The 8 m and 10 m behemoths are far too heavy for launching into space, weighing over 100 tons in glass and steel. Clearly the HST solution of launching a lightweight, ground-based telescope into space is not applicable for NGST.

The three study teams have proposed several paths to developing the NGST optics; widening the road by using a large launch fairing, using deployable segments for final assembly in space, and taking the next philosophical and technical step in reducing the weight of large optics. In this chapter, we do not fully address the difficulties or advantages of the two solutions to the width problem. Certainly the larger fairing solution appears to be a safe, straightforward path compared to the difficulties of deployment and subsequent alignments. Looking beyond NGST, however, both solutions will be important. We can foresee large space telescopes, perhaps 30 m in diameter, that are separated by hundreds of kilometers. These optical interferometers would be capable of imaging the surfaces of planets in other solar systems and the innermost portions of galaxies and AGN. Many technical issues are common to all three NGST studies and future missions. We cover these and the challenges of deployable optics in this chapter.

The Telescope Optics

We show a simplified view (Figure 6.1) of the GSFC 8 m concept for the NGST OTA, to illustrate its size relative to the 3.6 m Atlas IIAR shroud and the 2.4 m HST. Each of the eight deployable petals is comparable in size to the HST primary mirror, but the entire payload must fit into the payload envelope of a mid-sized launch vehicle. Packaging the telescope elements into the modest volume of the Atlas IIAR is not easy. In this concept, the backward folding petals limit the volume that may be used for the instruments, spacecraft bus, and sunshield.

In this chapter, we consider the OTA to consist of the following functional subsystems; the primary mirror assembly, the secondary and tertiary mirror assemblies, the secondary mirror deployable support structure, and the integrating structure (the core support structure). The primary mirror assembly is the key technological challenge for NGST and

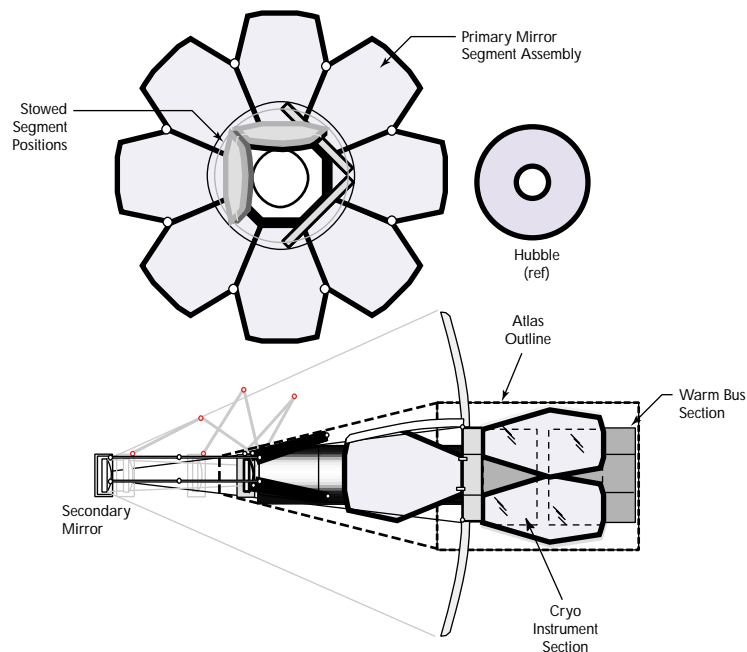

FIGURE 6.1. The GSFC NGST Telescope Concept. The deployment of the optical assembly is indicated by light dotted lines, while the Atlas IIAR fairing dimensions are shown by the heavy dotted lines. (HDOS/MSFC)

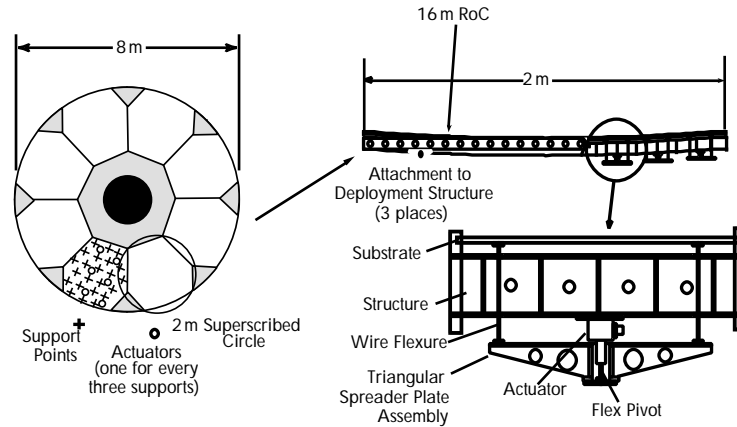

FIGURE 6.2. The TRW Primary Mirror Assembly Concept. (HDOS/TRW)

is illustrated in Figure 6.2. Except for the deployment mechanisms and petal positioning actuators, this drawing is also applicable to monolithic approaches such as the Lockheed Martin NGST. The secondary mirror assembly includes the 0.8 m secondary mirror and its position control actuator system. In the GSFC concept, the tertiary mirror is part of the Science Instrument module. But it too may require position actuators in a similar fashion as the secondary. Here we do not include the thermal and straylight baffling systems.

The optical design may be a straightforward Ritchey-Chretien two mirror system as in the Lockheed Martin 6 m concept. A three or possibly four mirror design helps to reduce the residual optical design errors, which unfortunately scale directly with size. While a two mirror design was satisfactory for the 2.4 m HST, the designer may use additional surfaces to alleviate the tight design construction tolerances and to create an image of the pupil (primary mirror) before the final focal plane. This pupil image is the ideal location for placing a fast-steering mirror for image stabilization and a deformable mirror (DM) for additional optical control. The surface of the DM is normally flat and can be adjusted to compensate for small surface errors in the primary mirror assembly. As we perfect the design of the primary mirror assembly and its adjustment capabilities, we will revisit the need for the DM. In any case, the specific optical prescription is not a fundamental issue at this stage of the concept development. The basic optical system, shown schematically in Figure 6.3, is capable of excellent (diffraction-limited) performance at $1\text{--}2\ \mu\text{m}$ over a total field of view of $10' \times 10'$.

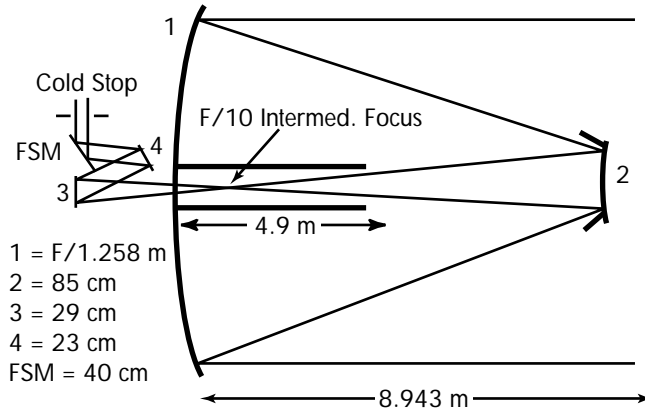

FIGURE 6.3. The Optical Path from the Primary Mirror to the Scientific Instruments. FSM = Fast Steering Mirror. (GSFC)

The Challenges

The NGST OTA presents to the optomechanical designer an array of challenges that are at the heart of the technical and economic feasibility of the project. Most are related to the construction, deployment, and performance of the primary mirror assembly. In the GSFC and TRW designs, the secondary mirror structure is deployed after launch, and the relative flexibility of this structure presents serious constraints on the vibration environment of the OTA. In this section, we outline these challenges and how they may be addressed. None is insurmountable.

Weight, Stowage Configuration and Deployment

The lift capacity and fairing size of affordable launchers (\$50M-100M) drive us into a new regime of lightweight optics. From the total available launch weight of 2800 kg for an Atlas IIAR, we can allocate approximately 1000-1250 kg for the OTA. This figure is similar for all three studies. We expect to use about one third to one half of that for the overall support structure, deployment, launch restraints, and a 20% reserve. Table 6.1 shows how this mass is used for a 6 m or 8 m primary mirror assembly in the TRW design, where the primary mirror assembly consists of the mirror supporting structures, shape and segment position control actuators, the mirror, and actuator mounting plates. Note that the weight remaining for the optical surface or faceplate corresponds to about 8.0 kg m^{-2} for the 8 m concept. We have assumed an actuator spacing of 0.5 m for adjusting low-order shape

Table 6.1. The Available Mass for 6 m and 8 m Primary Mirror Assemblies Imply Very Light Substrates and Areal Densities (HDOS/TRW)

Item	6 m Dia.	8 m Dia.	Basis of Estimate
Hex support ring	55	55	6 m dia. x 0.5 m CFRP ribbed box, 2 cm thickness x 1.5 fill factor
Forward cone	35	35	6 m x 0.5 m dia. CFRP shell, 2 mm thickness
Forward struts	11	11	2 x (5 m x 0.25 m) CFRP, 2.5 mm thickness
0.7 m dia. secondary mirror	12	12	35 kg m ⁻² passive mirror
Secondary mirror assembly	23	23	
Petal support structures	127	218	CFRP, 2.5 mm effective
Hinge and deploy	22	22	Six hinge and drive motors
Stow latches	11	11	12 Nitonol "one-shots"
Misc. support	22	22	
Actuators and cabling	114	170	One actuator (1 kg) per 0.25 m ²
Shape and alignment sensors	23	23	Secondary mirror theodolites
Thermal control	9	14	20 layers MLI and tie-downs
Total supporting mass (kg)	464	616	
Mass available for mirror (kg)	536	384	
Areal density (kg m⁻²)	21	8.5	

errors. Even if only position control is needed, the areal density is 11 kg m⁻². For most of the candidate materials, the corresponding range in thickness is 2–3 mm! Such low areal densities and small effective thickness for large mirrors represent an extraordinary leap in optical mirror technology and philosophy.

The aerospace industry has developed large, precision-deployable structures. The deployable NGST OTA concepts build on that experience and bring new challenges:

- The individual mirror assemblies, including backing structures, are thick, about 0.2 m, and rigid. Reflector panels for submillimeter and radio antennae are more flexible and very thin.
- The NGST mirror segments contain cabling to power the actuators. These must not constrain the movements of the deployment scheme.

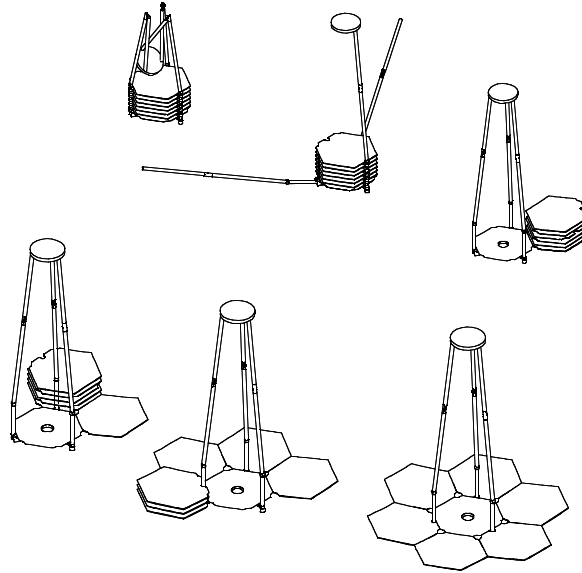

FIGURE 6.4. The TRW High Accuracy Reflector Development Prototype. The six hexagonal segments rotate together around the central segment, leaving one locked to its neighbor at each position. (TRW)

- The deployed OTA must be extremely insensitive to small disturbances in the spacecraft due to thermal changes or pointing maneuvers. Ideally, the latches and hinges must be free of hysteresis — they should return to their original positions to very great precision.
- The deployment concept must permit testing to provide assurance that the system will indeed deploy and that latches will operate after launch and at cold deployment temperatures.

The TRW deployment design is based upon the High Accuracy Reflector Development (HARD) deployment mechanism shown in Figure 6.4. Other concepts include the Harris Corp. compound double-folded system (a Lockheed Martin option) and the MSFC/HDOS up-down folded petal design illustrated in Figure 6.1. For all deployable designs, the various architectural options (weight, volume, etc.) and the small details that differentiate precision optical structures from more tolerant radio applications must be carefully considered.

Optical Performance and Design Requirements

The science drivers of HST-like resolution in the NIR and wide field imaging mean that high quality optics are required for the primary mir-

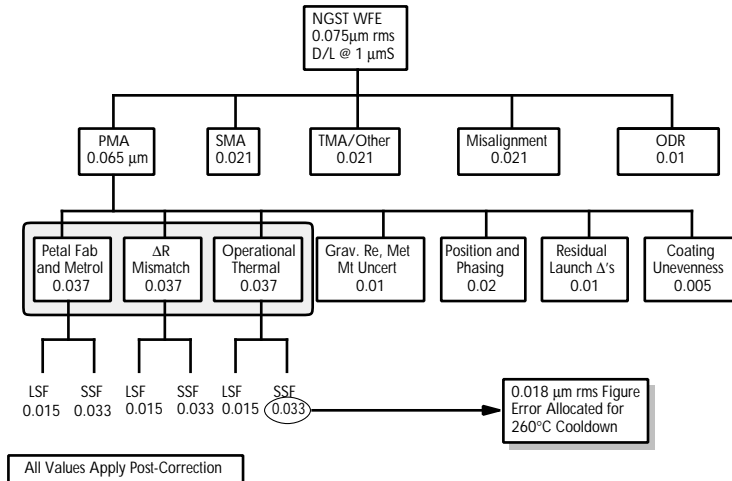

FIGURE 6.5. A Simplified Wavefront Error Budget for the TRW Design with a Segmented Primary Mirror. The GSFC concept has a similar budget. All the numerical values are in mm RMS and are assumed to add in quadrature. The primary mirror accounts for more than half of the budget. The contributions of the individual elements are broken down into long and short spatial frequency components, LSF and SSF respectively. (HDOS/TRW)

ror assembly. To illustrate the overall quality of the optics and the various effects that must be considered, we show the wavefront error (WFE) budget for the TRW design (Figure 6.5). This design is intended to be diffraction limited at $\lambda = 1 \mu\text{m}$. All errors are added in quadrature; and most of the contributions arise in the primary mirror assembly. If we relax our goal to diffraction limited operation at $\lambda = 2 \mu\text{m}$, we simply double the various values. The surface quality of the fabricated mirror segments should be about 1/30 of the wavelength of visible light over dimensions smaller than the spacing between shape actuators ($\ll 0.5 \text{ m}$). This is easily achieved in the optical fabrication of ground telescopes and instruments, but it may be a challenge for the relatively flexible segments in the TRW and GSFC concepts. All three study teams concluded that it is impractical to achieve the required precision over larger scales without some form of active compensation. In this case, we can relax our fabrication tolerance to perhaps $\sim 1 \mu\text{m}$ between adjustment actuators. The shape control actuators can reduce these large scale errors by at least a factor of thirty, i.e. there will be residual errors of 1–3% of the error to be corrected. We note that the WFE budget for the Lockheed Martin concept using a monolithic primary does not need to include the significant contributions due to petal positioning and radius of curvature (focus)

mismatch between the different petals. These may amount to 40–50% of the primary mirror assembly WFE budget in a deployable system.

Radius of Curvature Errors

Unlike conventional monolithic primary mirrors, we must place an extremely strict tolerance on the radii of curvature (twice the focal length) of all the segments. The HST, a monolithic telescope with 1/80th wave optics (excepting the spherical aberration error) could have had a 2 mm error in its radius of curvature. In that case, a small adjustment to the secondary mirror distance would have adequately compensated for the fabrication tolerance with no discernible effect on the optical performance. The 6 m monolithic Lockheed Martin design is just as tolerant. For segmented designs, however, all segments must have almost identical radii of curvature, to within 50 μm or a precision of about 2.5 parts per million. Such a precision corresponds to segment surfaces identical to within 0.07 μm RMS — after cooling the segments by 250 K! Even if polishing techniques could produce identical segments at room temperature, tiny differences in the material properties from segment to segment would result in unacceptable deformations at $T_{\text{primary}} \sim 50$ K. *Some form of active figure compensation will be needed for any large, passively cooled mirror.*

Limits to Deformable Mirror Corrections in the Pupil Plane

The large optics programs of the Strategic Defense Initiative Organization (SDIO) faced similar difficulties in correcting the radii of curvature and large scale deformations in segmented mirrors. One solution was a deformable mirror (DM) with many hundreds of actuators placed at an image of the primary mirror. Small changes in the shape of the DM compensate for identical errors in the primary mirror over larger scales. This reduces the number of actuators and adjustments needed for the primary mirror segments. For large fields of view, however, this approach can create large field-dependent image degradation. The system magnification, $M \sim D_{\text{primary}}/D_{\text{DM}}$, increases the apparent angle between two sources at the DM. If the DM is adjusted to correct the optical wavefront for a target in the middle of the field, the magnification causes it to overcorrect the light beam from a target on the edge of the field. This situation is illustrated in Figure 6.6. We have examined this error for a simple displacement between two petals (piston), a radius of curvature mismatch (different focal lengths), and random large scale shape errors. If we consider the formula for only piston errors, a magnification of 64, and a half-field angle of 5 arcminutes, we obtain a residual error at the edge of the field, $\delta = 0.004 \delta_{\text{piston}}$. To satisfy our piston

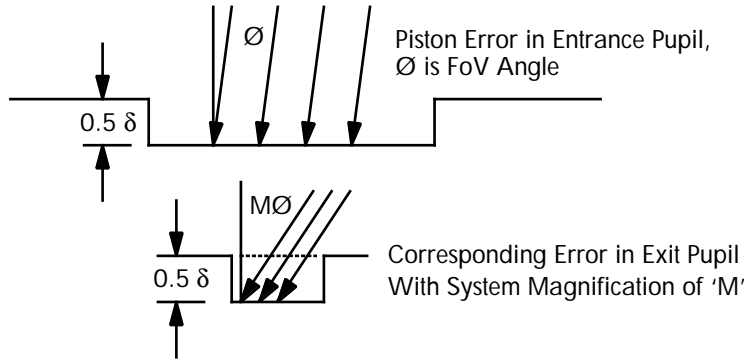

Phase Error Difference Between On-Axis and Field Ray is

$$WFE = \delta [1 - (\cos M\theta)^{-1}]$$

FIGURE 6.6. The Deformable Mirror Field of View Dilemma. To retain a good field of view, the initial figure errors must not be worse than 3 μm RMS in piston setting and 30 μm RMS over an entire segment. The RMS errors at the edge of the field for focus and large-scale figure errors are 0.6 and 0.2 times those for piston, respectively. (HDOS/TRW)

error budget of 0.02 waves RMS for the primary mirror, each segment must be set to an accuracy of 2–3 μm or the images will be degraded at the edge of the field. Larger magnifications, such as those in the GSFC design, make the problem worse. *Clearly, we will need to precisely adjust the position of each segment after it has been deployed and has reached its operating temperature.* In a similar fashion, we conclude that each segment must either be precisely figured based upon its performance at a specific operating temperature or have sufficient shape control to adjust radius of curvature and other large scale surface errors to bring them within the range of correction of a deformable mirror.

The Implications of Operating at Cryogenic Temperatures

The scientific requirement for telescope temperatures in the range 40–60K has challenging implications for the design of the OTA. First, the materials used for the mirror and the mirror support structures can undergo large dimensional changes as they cool from room temperature to ~50K. As shown in Figure 6.7, an 8 m beryllium mirror, for example, will shrink by 0.13% or approximately 10 mm in diameter. If the entire OTA were constructed of the same material, the scale would change but the optical performance would not be affected. The telescope would simply be slightly smaller.

Even elements made of the same material may not behave identical-

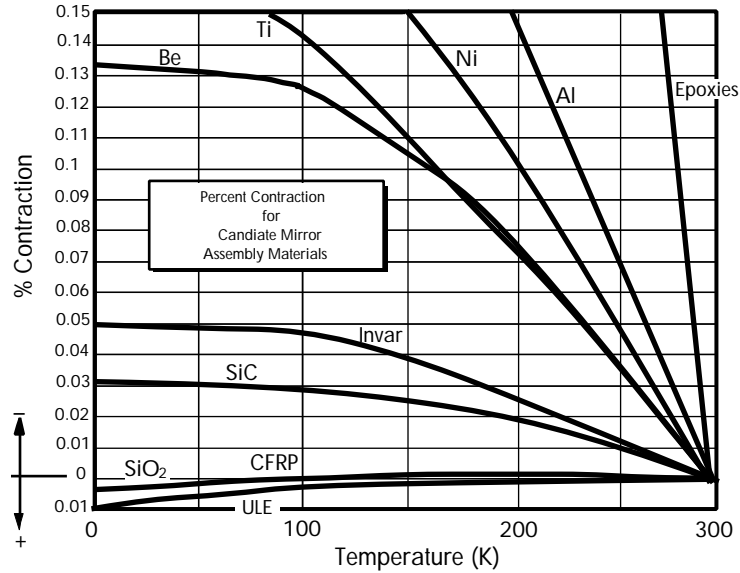

FIGURE 6.7. Contraction Data for Candidate NGST Telescope Materials. (HDOS/TRW)

ly, however. Small changes in the coefficient of expansion with volume or along certain dimensions (anisotropy) can create significant shape errors and displacements as the mirrors cool down. Again, shape control actuators and precision positioning devices can be used to compensate for these errors. To minimize the number of such actuators and their total motion, we will select homogeneous and isotropic materials with low shrinkage, (low $\Delta L/L$). Fused quartz and fused silica are two good materials. The optical industry has vast experience in the manufacture of low expansion and isotropic glass for use in ground based telescopes. Glass is also handy since it is transparent and can be inspected for residual strain and anisotropy. Beryllium has the advantage of a high strength-to-mass ratio and has been demonstrated to work well at cryogenic temperatures (SIRTF). We will also consider other materials such as silicon carbide (SiC) and nickel (Ni) for manufacturing the large 3 m petals through replication for cost efficiency. *The cost of manufacture of the thin segments or the single monolith is the dominant manufacturing cost of the OTA.*

We mention two other effects of cold temperature, one obvious and the other subtle. The first effect is that passive radiation cooling without the use of cold cryogen like liquid helium is very inefficient for removing heat. As a result, we must minimize heating of the OTA by radiation, thermal conduction from the spacecraft or instrument module, and actu-

ator power. The position and shape actuators must either hold their position when power is removed or each must consume less than a few milliwatts. Our second concern is how structures behave at such low temperatures. At higher temperatures, structures tend to damp small vibrations through small internal friction. This damping sets the ultimate amplitude of any excited structural modes, such as twisting, nodding, and other bending modes. At low temperatures and for very low amplitude vibrations or strain levels, the damping in some materials may drop by several orders of magnitude. In this case, the structure becomes a tuning fork, and the deflections increase by a similar amount. This behavior is most critical in the OTA, where deflections of the optical elements must remain below a small fraction of a wavelength of light. As part of the technology development program, we will test the damping in sample materials at low temperatures and low amplitudes.

Ultralightweight Mirror Designs

The NGST mirrors will be revolutionary compared with the current state of the art for large optical mirrors. They will be an order of magnitude lighter, yet must be produced more economically than today's designs for large, lightweight optics. Moreover, their operational temperature is 50 K or about 250 K below the temperature at which they are polished. The combination of size, weight and temperature change make these mirrors well beyond what has been achieved by industry. On the other hand, these optics work in a relatively benign environment: negligible accelerations and very constant thermal loads. Taking advantage of these factors and considering modern manufacturing techniques, the three study teams arrived at essentially the same, paradigm-breaking solution: *replacing the traditional stiffness of glass mirrors with computer control*. Instead of launching a lightweight but essentially stiff mirror such as the HST primary, the NGST concepts use thin, reflecting membranes that are supported and controlled by mechanical actuators mounted on a stiff backing structure. Since neither the backing structure nor the thin membrane is mechanically stable over meter-scale dimensions, the actuators must be adjusted to correct the overall shape of the reflecting surface. The membrane, on the other hand, must have a smooth, specular surface and must maintain the proper figure in the regions between actuators. Previous SDIO programs (e.g., the Large Advanced Mirror Program and Adaptive Large Optics Technologies) have utilized 17 mm thick meniscus segments and dozens of actuators, primarily for alignment control (e.g., piston). However, the NGST mirror designs are almost 10 times thinner (lighter) and make full use of

computer control. Can 3–6 m size, 2 mm thick membranes be manufactured? The three concepts considered two different manufacturing processes: traditional glass manufacture and replication.

Thin Glass Meniscus

In a recent paper, Angel et al. (1997) describe a technique for manufacturing a large diameter (6–8 m) meniscus made of fused silica, fused quartz, or borosilicate glass. The method starts with two thick pieces of glass of matched curvature that are bonded with a thin film of flexible pitch. Computer-controlled grinding and polishing machines reduce the upper piece to a thin membrane, which has excellent surface polish and the correct figure over length scales much greater than the spacing of the support actuators (~10 cm). The pitch is melted, and the membrane is gently lifted and placed on the support structure. Scaling from a 0.52 m diameter prototype (Figure 6.8), the Lockheed Martin team estimates that a 6 m mirror would have a mass of approximately 720 kg, including the meniscus, 3600 actuators, and a composite backing structure. The same technique would be applicable for smaller diameter segments of a deployable primary mirror assembly. The areal density, 25 kg m^{-2} , is appropriate for a 6 m mirror but must be reduced for an 8 m primary mirror assembly. However, Angel et al. have shown that the 0.52 m prototype is essentially diffraction-limited at $2 \mu\text{m}$, even with stresses due to gravity. If the stresses of polishing and cooling the large diameter mirror can be reduced below 1 g, or, if the mass of the actuators (now 50 gm) can be reduced, even more lightweight structures are feasible with this technique.

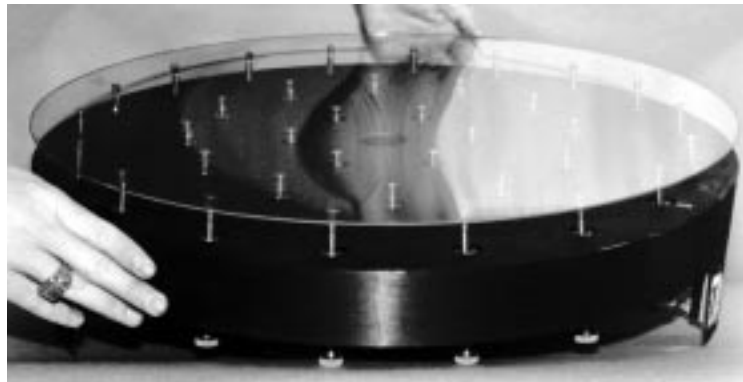

FIGURE 6.8. The Membrane with Active Rigid Support Prototype (MARS). A 0.52 m diameter, 2 mm thick glass membrane supported by 36 active position actuators mounted on a carbon fiber reinforced support structure. (University of Arizona Mirror Lab, Composite Optics Inc.)

Replicated Membranes

The TRW and GSFC studies considered replication to produce petals with the correct surface polish and figure. These techniques included forming a quartz membrane over precision figured graphite dies or replicating SiC onto a precision mandrel by the CVD process. After replication, the membranes would require minimal figuring, except for minor corrections, and light polishing to achieve the requisite specular finish. The promise of this approach is reduced cost and streamlined production schedules. However, neither of these techniques has been demonstrated for optical surfaces larger than 0.5 m.

Several other fabrication techniques are promising but appear to suffer one or more significant drawbacks. Electroformed nickel has a successful history in replicated mirrors, ranging from World War II anti-aircraft searchlights to cylindrical X-ray optics. However, the high shrinkage rate (Figure 6.7) and the high density of nickel (9 gm cm^{-3}) are serious drawbacks. Pyrex and Zerodur glasses can be spin-cast to moderately thin meniscus shapes. The low thermal expansion rate of Zerodur only applies at room temperature and increases substantially as the temperature of the mirror is reduced to 50 K. Carbon fiber reinforced plastics (CFRP, often referred to as composites) are strong and can be replicated at very low cost. The thickness of the epoxies, the replicating medium, must be controlled to a manufacturing accuracy of $10 \mu\text{m}$ to prevent unequal contractions during curing. The same expansion and contraction concerns are applicable to the variations in faceplate thickness and the homogeneity of the material.

A Halfway Step

With modern materials, we may be able to use lightweight, inherently accurate reflecting elements that are steered into alignment to form the primary mirror assembly. The Multi-Mirror Telescope on Mt. Hopkins, Arizona and the Keck telescopes use lightweight glass segments and adjust them periodically to maintain good (but not diffraction-limited) optical performance. Since only modest corrections to the optical wavefront are possible with a deformable mirror, the NGST segments must be nearly diffraction-limited at their operating temperature of 50 K. Experience with the SIRTf beryllium mirror and other materials has shown that mirrors can be reliably figured to be diffraction limited at cryogenic temperatures. This procedure, cryofiguring, involves several iterations of figuring at room temperature, testing at cryogenic temperatures, and refiguring at room temperature. With a beryllium or

SiC mirror, most of the dimensional changes occur by 70 K and the testing can be done at liquid nitrogen temperatures. Even with modern measurement and figuring techniques, cryofiguring is expensive. For NGST, we would use large segments of homogeneous material to minimize distortions caused by cooling. Large segments are difficult to produce and test, since the effects of gravity grow rapidly with scale. On the other hand, many smaller segments would require different shapes and figures, again increasing the manufacturing cost. *Reducing the costs of cryofiguring will be a key goal of the technology development plan for ultralightweight mirrors.*

Correcting Large Shape Errors

Each of the three designs relies on some form of figure control to compensate for a myriad of effects; shrinkage due to cooling, distortions due to small temperature differences on the mirror, imperfect compensation for gravity release, and dimensional changes in the backing structures. For relatively modest shape errors (e.g., ~5–10 waves over the entire mirror or segment), we can use a DM at the image of the pupil and still retain excellent imaging over a wide field of view. This method would be used for the Be or SiC reflectors and sets the accuracy that such a system must meet. In particular, we would need reliable cryofiguring techniques and predictions of the primary mirror operating temperatures. Temperature control of the primary mirror segments may be required (necessitating a slightly higher operating temperature).

Primary mirror assemblies with thin membranes and many shape actuators may not require a DM, since they must be capable of correcting larger errors to similar precision. The degree of correction will depend on the thickness of the membrane and the number of actuators. Angel et al. have shown that for a uniform stress on the mirror (e.g., gravity), the ideal balance between membrane mass and actuator spacing is achieved when the membrane and actuator masses are equal. If actuator masses can be reduced, so may the thickness of the membrane. Handling concerns and the ability to correctly figure the edges of the membrane set a practical limit on thickness for a given material. A higher density of actuators may be needed to correct surface errors at the edges of the thin membranes or the stresses remaining from replication techniques. Since each actuator also causes errors on small scales as it bends the membrane, *we should not attempt to correct more than a wave of local error over any three-actuator span, else the residual error would be >0.03 waves and exceed our error budget.*

The small dimples created by the actuator forces also place con-



FIGURE 6.9. The Effects of Gravity on the Surface of the MARS. Laser interferometry reveals a small bump on the surface above each of the actuators. The measured departure from a perfectly spherical surface is $0.053 \mu\text{m}$ RMS. The calculated bumps for a $2 \mu\text{m}$ thick Zerodur shell is $0.050 \mu\text{m}$ RMS. (University of Arizona Mirror Lab, Composite Optics Inc.)

straints on the number and spacing of actuators. Figure 6.9 shows the errors in the MARS mirror surface with the actuators set in their optimum position and simply supporting the weight of the mirror. The optical effects of these dimples are easy to measure and are excellent indicators of the stresses imposed on the mirror by each actuator. Unfortunately, they are barely acceptable at the 1 g level. Thus, we conclude that the pressure exerted by each actuator should be less than that due to gravity. This constraint is particularly important for large scale corrections to the radius of curvature or replication errors. These put the steeply figured NGST mirror into compression and create larger stresses than simply bending a flat sheet. In this case, the number of actuators near the edge of the segments will be directly related to the quality of the replicated surface. This will be a key area in the development of replication and cryofiguring technologies.

Making Sure It Works

Whether produced by grinding and polishing or by replication, the NGST primary mirror segments must be verified to have peak to valley tolerances of about $0.15\ \mu\text{m}$ on small scales and the ability, through adjustment, to have similar precision on large scales. The concept studies devoted much attention to the verification process, which is intimately tied to the manufacturing flow. A typical approach separates the issues of wavefront accuracy and control, cryogenic wavefront performance, deployment, and dynamics into three parallel activities. All three studies include verification steps similar to those given below:

Verifying the Primary Mirror Segments

1. Pre-Fabrication Cryogenic Screening: We measure deformations of the machined or replicated mirror segments at low temperatures ($\sim 70\ \text{K}$) using holography (laser metrology). If they show deformations that are greater than can be corrected by the shape actuators or a DM, they are rejected.
2. Post-Fabrication Cryogenic Verifications: We figure and polish the segments that pass the first screening on a support system which counteracts the effects of gravity (metrology mount). Using a full-aperture holographic test facility that can be cooled to $\sim 50\text{--}70\ \text{K}$, we measure the surface accuracy at $290\ \text{K}$ (room temperature) and at $50\ \text{K}$. The two measurements are needed because the segment will show large deformations due to the effects of gravity. If we see changes in the figure that are outside the range of the shape actuators, we will need to iterate the figuring and cryogenic test cycle. Our goal will be to minimize or eliminate the need for such a step.
3. Segment Assembly-Level Verification: Before accepting the mirror segments, we mate each mirror with its actuators and verify that the deformations observed in Step 2 can be satisfactorily removed. Again, we do the holographic measurements before and after moving the actuators. These steps create a baseline measure of the segment in an uncompensated gravity environment. We compare the performance of the segment after vibration (launch loads) and acoustic testing (high-frequency vibrations) to the baseline. For one of the mated segments, we would verify the loads (bending, twisting, and shearing) that the actuators induce at the lower temperatures.

Verifying the Deployment System

On a parallel path, we would verify the deployment system.

1. Basic Operation and Launch Survival: We would check the deploy-

ment and latching of the entire system at room temperature before and after vibration and acoustic testing. All cables, multi-layered insulation (MLI) blankets, and similar elements will be included. The mirror segments would be simulated in mass and shape. Since the thermal stress caused by rapid cooling can also be significant, we will repeat the deployment and latching tests at operating temperatures (~50–70 K) in a large test chamber.

2. Deployment Accuracy and Stability: We can test the accuracy of the deployment and subsequent positioning and the stability at operating temperature using metrology on surrogate optics .
3. Deployed Dynamics and Jitter Resistance: The stiffness of the deployed structure is important. We will compare the vibration characteristics of the latched segments to computed predictions in several different gravity orientations. Because of concerns regarding low damping, these tests will be repeated at the low operating temperatures.

Testing the Telescope Alignment, Sensing and Control System

The ability to adjust the telescope optical performance after deployment is a crucial element in all three study concepts. We must be able to measure the optical properties of the entire telescope system and set mirror positioning actuators, figure correcting actuators, and the DM to great precision. The space astronomy community has gained considerable experience in this arena after the discovery of spherical aberration in HST. Using distortions in the out of focus images of bright stars, astronomers and optical scientists were able to deduce not only the sense and degree of spherical aberration in the primary mirror but also the residual small scale errors of manufacture to levels almost immeasurable in 1982. These are the kind of techniques that will be used to adjust NGST. Figure 6.10 shows the measured performance of a high precision deformable mirror. This particular DM has superb precision, with repeatable positioning to within 1/1000th wave. Such a DM would provide diffraction-limited performance at visible wavelengths if the wavefront errors across the mirror segments are primarily on large scales (~0.5 m). Figure 6.11 shows the simulated figure errors for a segmented NGST mirror before and after correction of thermal distortions using small piston motions and the DM. The ultimate science image of the test star is essentially perfect.

JPL has simulated each alignment step using IMOS software and a detailed structural model of the GSFC NGST. These studies establish the required precision of each optical component and our ability to take a misaligned system after deployment to a perfectly aligned and adjusted

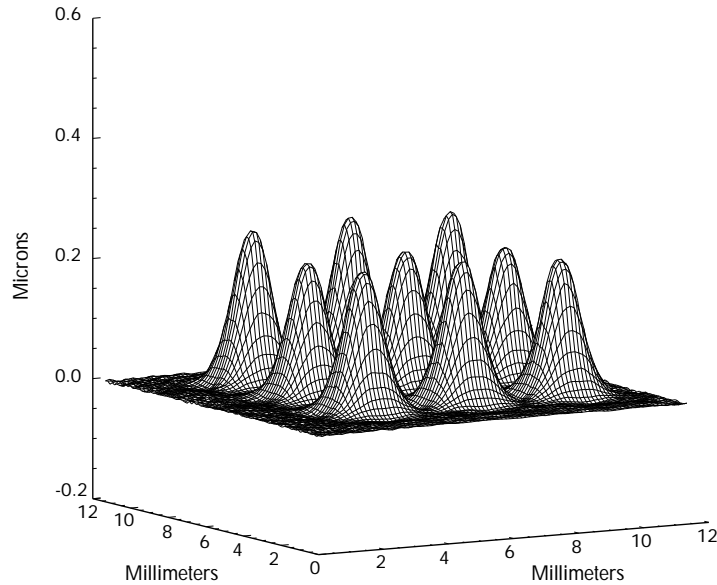

FIGURE 6.10. Measured mirror actuation for a high density DM developed by Xinetics Inc. for CODEX, a proposed coronagraphic instrument for HST. Vertical axis gives surface displacement in millimeters. Actuator elements are spaced by 1 mm in a square array over the DM. Laboratory measurements provide an 8 x 8 grid of sample points per actuator. This is the surface displacement measured with a stroke of about $0.270 \mu\text{m}$ commanded on every third actuator in each dimension. (NASA/JPL/STScI)

system for science imaging. In the development stage, these models will be meshed with real subsystems to verify the alignment, sensing, and control system. In particular, we would test the overall alignment system with a small scale version of the NGST, perhaps a 1/10 scale test-bed. Testing at larger scales is costly and, because of the significant effects of gravity, may provide little additional information if the authority of the actuators is insufficient. The alignment steps are:

1. Initial deployment and capture: This is a coarse alignment to combine the images from the separate segments into a single image.
2. Initialization or fine alignment: Phasing the independent segments is a difficult step, one that is not required for the monolithic approach. Using a shearing interferometer or using phase retrieval techniques, we adjust position and the large-scale figures of the segments to achieve $1\text{--}2 \mu\text{m}$ diffraction-limited imaging performance.
3. Image stabilization: Although our initial studies indicate that the deployed reflectors and support structures should be stable, we may

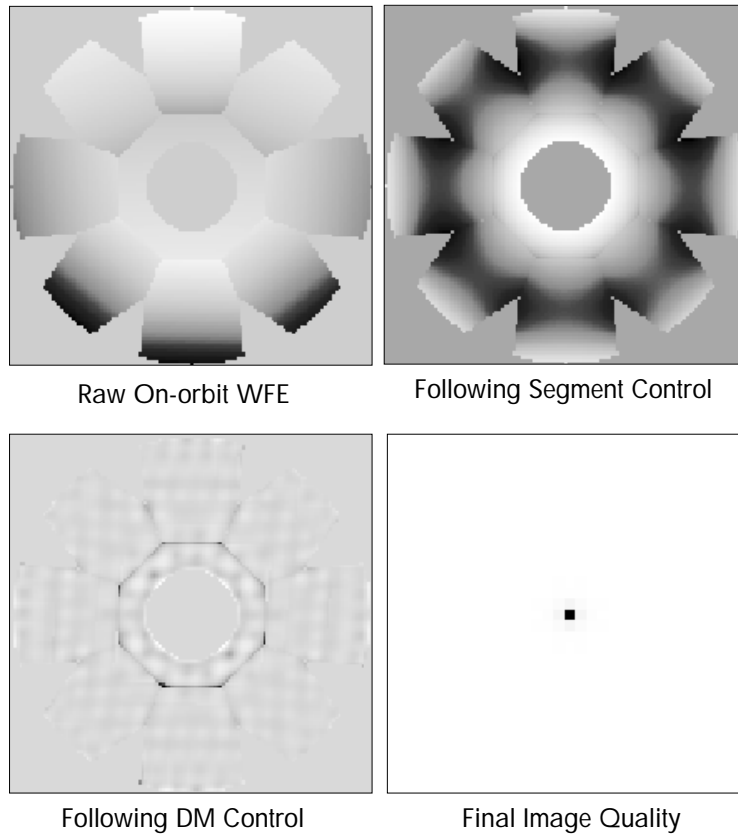

FIGURE 6.11. The simulated alignment of a segmented NGST. The first-panel indicates the wavefront error of the segmented mirror after initial segment deployment ($54\ \mu\text{m}$ RMS). The second panel shows the wavefront error after segment control ($0.8\ \mu\text{m}$ RMS). The third and fourth panels show the wavefront and stellar image after correction by the DM ($0.03\ \mu\text{m}$ RMS). (NASA/JPL)

need an autonomous system to control the alignment of the separate reflectors on short time scales. Such a system would require laser or edge sensing of the relative positions of the segments. We would test the precision and repeatability of such a system at room temperature and at cold operating temperatures.

Each of these steps would be verified first by simulation and then by use in an optical testbed with prototype and flight qualified hardware (sensors, actuators, DM, and flight software).

Reaching Readiness

We are encouraged by the convergence of the three study groups on a new and exciting paradigm for large lightweight mirrors. This paradigm is perfectly suited to constraints and conditions of high orbit space missions. Today's mirror fabrication and deployment technologies are very close to providing the assemblies required for NGST. Without the cost savings of replication, we estimate that direct fabrication of the meniscus membranes for the MARS segments would cost approximately \$40 M ('96). The goal of the technology development process discussed in Chapter 10 is to reduce and constrain these costs. We also must develop the specialized hardware required for operation at low temperatures. Although the large primary mirror is the tall pole for NGST readiness, we have confidence that this technology will be ready for NGST development in 2003.

CHAPTER 7

The Science Instrument Module: Recording the Light from Stars and Galaxies

BY CONSIDERING THE SI MODULE on the same footing as the OTA and the rest of the spacecraft, the NGST team correctly ascribed great importance to the scientific instruments. Superbly sensitive cameras are used to form and record images in the telescope field-of-view over a wide range of wavelengths. Innovative spectrographs disperse the light from specific targets to determine their excitation, chemical compositions, and their motion relative to Earth and their neighbors. In addition, the SI Module finely guides the telescope using the light from serendipitous stars in its field. The SI Module establishes the precision pointing of NGST relative to the celestial sphere. In short, it is the astronomers' hands and eyes.

A large portion of the NGST scientific program consists of performing deep surveys of faint galaxies. To complete these surveys in the available time (Appendix C), the science instruments must be very efficient and cover a large field of view. This is particularly vital for the cameras, for they identify the targets for future studies. Ideally, the spectrographs should be able to take the spectra of many objects at once (multi-object spectroscopy). High efficiency means that the electronic detectors should be almost perfect at recording light (QE ~100%) and produce minimal noise to compete with the faint signals. Likewise, we endeavor to minimize the number of optical elements in each instrument. To keep the SI Module itself from contributing to the background, we must arrange for it to be kept at very low temperatures, <60 K for the NIR ($\lambda = 1\text{--}5\ \mu\text{m}$) and lower within the MIR instrument ($\lambda > 10\ \mu\text{m}$). Like the rest of NGST, the SI Module must make the best use of mass and volume. In practice, we must consider the SI Module as a single integrated unit, rather than a collection of self-sufficient instruments. It does not matter that a single team designs the SI Module. We will need the expertise of the entire space astronomy community to build the best possible telescope and scientific instruments.

Focal Plane Arrangement

The angular size and physical region of the telescope focal plane is a vital resource that must be shared by the science instruments and fine guidance mechanisms. The design faces three possible choices for accommodating multiple science instruments.

1. Temporal sharing. The instruments all use the same field at the focal plane. A rotating mirror is used to steer the telescope beam into each of the instruments one at a time. This is a practical solution in a ground-based observatory but would be very inefficient for NGST where the emphasis is on surveys. The required beam switching mechanism is also undesirable for space application since it poses the risk of mechanism malfunction.
2. Geometrical sharing. The instruments' fields of view are side-by-side, and each instrument has permanent access to the sky. This is a very efficient solution for surveys. Moreover, no additional reflection or beam splitting is required. For a single target, however, it is less efficient if the same field needs to be observed with different instruments. For very large angular fields, the telescope optics may require more elements to provide excellent images over the required field. This is not a problem for NGST.
3. Spectral sharing. All instruments use the same physical and angular field and the common incoming beam is split spectrally (dichroic beamsplitting) to feed each instrument. This is a very efficient solution for both surveys and pointed observations. The drawbacks to this approach are the light losses due to the use of the beamsplitters. In particular, the spectral region near the critical splitting wavelength is shared between the two instruments - usually with some light loss. The TRW NGST concept combines spectral sharing with geometrical sharing in order to minimize the losses associated with sharp cutoff dichroic filters. Spectral splitting usually applies to a single type of instrument. Cameras and spectrographs cannot be fed simultaneously with this scheme. They must either time share the beam or use different fields of view.

For NGST, efficiency is paramount; and the second and third solutions or a combination of both, are the best choices. Two possible implementations are illustrated in Figure 7.1.

In the case of the NIR camera, the desired field of view is so large (say 4' x 4'), and the spectral band so wide (4 octaves), that additional splitting is required. Both geometrical and spectral splitting can be used as shown in Figure 7.2.

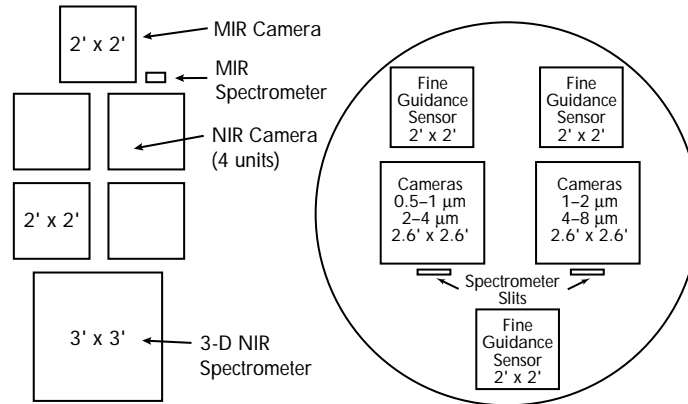

FIGURE 7.1 At left, geometrical sharing as selected by the GSFC study (the Lockheed Martin solution is similar). At right, a combination of spectral and geometrical sharing as selected by the TRW team. (NASA/GSFC, TRW)

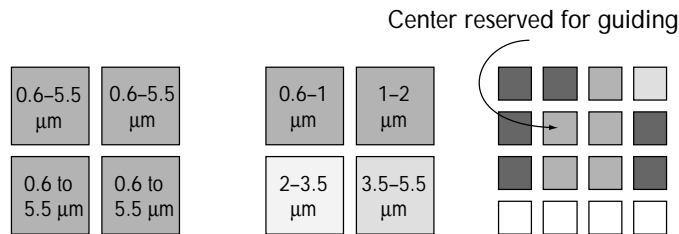

FIGURE 7.2. Three possible implementations for the NIR focal plane arrangement. At left, the 4' x 4' field is shared by 4 subcameras of a more manageable 2' x 2' field size with 4k x 4k focal plane arrays. All of these subcameras are identical and use the same type of detector covering the entire spectral NIR band (GSFC study scheme). Spectral bands are selected in each subcamera by filters. The solution shown at the center follows the same beam splitting principle, but each subcamera is now specialized spectrally, with detectors that may be different and optimized for each spectral band (TRW study scheme). In these first two cases the detectors are assembled from 1k x 1k devices. At right, the field of view is split into multiple beams each feeding a camera with either a single detector chip or a modest array that is optimized for a specific spectral band (Lockheed Martin study scheme). (STScI)

Detectors

The importance of good detectors cannot be overemphasized. For instance, in the 1960–1980 period, ground-based visible astronomy made enormous leaps forward based entirely on the availability of photoelectric detectors (photomultipliers and image intensifiers) and solid-state devices such as CCDs. Infrared detectors are now approaching the quality and size of 1990 optical detectors. The best near-infrared detectors for astronomy are made of either indium-antimonide (InSb) or mercury-cadmium-telluride (HgCdTe). Both types offer a level of performance approaching the requirements for NGST as described in Chapter 2, and the improvements that must be made fall under the NGST technology-development program. InSb covers the entire NIR spectral range and can be extended into the visible to about $0.6\ \mu\text{m}$ with proper antireflection coatings. These detectors can operate at 30–35 K and deliver low dark current performance. With a composition selected to cover only up to $3\ \mu\text{m}$, HgCdTe devices have the advantage of operating at higher temperatures (60–70 K), but for applications beyond that wavelength, they must be cooled to $\sim 35\ \text{K}$. Unlike the case for InSb, the wavelength coverage for current HgCdTe devices cannot be extended down to visible wavelengths. An additional visible camera, probably using a CCD, would be required if NGST imaging were to cover this spectral region.

Both types of NIR detectors have been made into $1\text{k} \times 1\text{k}$ devices. Making larger devices is difficult because of the different characteristics of the absorbing material and the underlying silicon electronics. Since NGST requires a very large format, detectors for both the cameras and multi-object spectrograph will be made of mosaics of $1\text{k} \times 1\text{k}$ arrays. One possible arrangement leading to a $4\text{k} \times 4\text{k}$ composite detector is shown in Figure 7.3. In this case, four $1\text{k} \times 1\text{k}$ devices can fit tightly into $2\text{k} \times 2\text{k}$ groups and so forth. The small gaps between individual chips are not detrimental since most observations will be for surveys. Gaps between the four $2\text{k} \times 2\text{k}$ groups are used for routing output wires and total less than 10% of the detector area.

Today the best detector for the MIR spectral region is made of arsenic-doped silicon (Si:As) using impurity band conduction (IBC). This detector offers relatively high quantum efficiency ($\text{QE} = 0.5$) and good spectral coverage from $\lambda = 5\text{--}28\ \mu\text{m}$ (Figure 7.4). Like any high-performance detector working at these long wavelengths, it needs to be cooled to about 6 K. This is too low to be satisfied by passive cooling and will require either stored cryogen or an active cooling system. An alternative material for use in the MIR is a specially alloyed HgCdTe that can be operated at higher temperatures but will have a higher dark current and a limited wavelength region, $1 < \lambda < 12\ \mu\text{m}$.

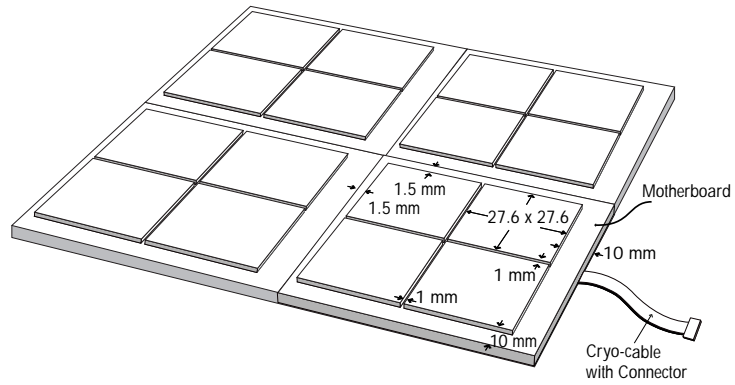

FIGURE 7.3. Large-format detectors can be made of a mosaic of 1k x 1k arrays. (STScI/SBRC)

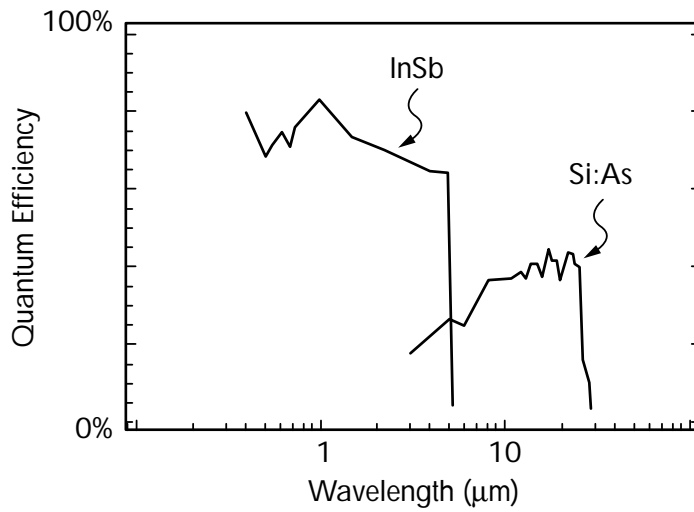

FIGURE 7.4. The excellent quantum efficiency of InSb and Si:As detectors covers the wavelength range 0.6–28 μm. (STScI)

Fine Guidance and Active Optical Control

NGST, like HST, can use a portion of the science field of view for precision guiding by stars. The large apertures provide ample light from relatively faint stars to reduce the image jitter for frequencies lower than a few Hz. Unlike the HST design, where the pointing adjustments are applied to the entire spacecraft, all three study concepts use a fast-steering mirror in the SI Module to do the correction. The OTA and SI Module are allowed to wobble slightly due to larger pointing errors over longer time scales. This arrangement eliminates the need for rapid impulses on the spacecraft and permits a less rigid OTA and support structure. Given the lightweight and relatively flexible mirror designs described in Chapter 6, this is an essential design philosophy for the TRW and GSFC concepts. In the more rigid Lockheed Martin concept, it reduces weight and cost. As we indicate in the following subsections, we can choose to integrate the guiding function with the science instruments with no significant impact on science. If an independent guiding instrument is preferred, it will have comparable performance to a science camera and could be used as a specialized science instrument.

Choosing the Guiding Sensor

The GSFC study saw a significant advantage using the NIR science camera as the guiding sensor. We would save the cost of a special guiding system and not be forced to accommodate a larger, shared field of view. The NGST science drives the NIR camera itself to have an adequate field of view for the purpose of guiding. And the large number of independent 1k x 1k detectors needed to cover the FOV permits the use of one for guiding at little scientific cost. In normal operations, the SSM computer can select the appropriate stars for guiding without ground intervention. Following short exposures of the desired field, the computer will identify the brightest star for guiding. Within a single 1k x 1k device, the region around the bright star will be interrogated at a fast rate to supply the guiding error signal. The computer will handle the rest of that device like the others in the camera for science imaging.

Table 7.1 shows the number of stars brighter than selected I- and K-band magnitudes in the GSFC 4' x 4' NIR camera field. We use statistics from the galactic poles where the number of stars is the lowest. To ensure a 95% probability of finding at least one guide star of the selected magnitude or brighter, we need an average of three stars in the field. Table 7.1 indicates that with a field of 4' x 4', the guiding sensor must be able to guide on stars of about 16.5 magnitude in the I band (0.8 μm) or magnitude 15.5 in the K band (2.2 μm). (Fainter objects have greater astronomical magnitudes.)

TABLE 7.1. Number of Stars in a 4' x 4' Field at the Galactic Poles

Magnitude	I Band	K Band
15	1.4	2.0
16	2.3	3.7
17	4.2	6.7
18	7.7	12.0

The measuring error of a stellar guiding sensor arises from noise compared with the strength of the signal. In engineering terms, this “noise equivalent angle” (NEA) is calculated using the noise of the detector, the total number of detected stellar photons, and the shape of a star image compared with the size of a detector element or pixel. In Figure 7.4, we show the results for different sampling times given the GSF 8 m telescope and a K = 16.5 star ($\lambda/\Delta\lambda = 4$) in Figure 7.4. Shorter sampling times reduce the signal from the star and increase the NRA. In the K-band, the telescope optics should provide a diffraction-limited image with a 51 milliarcseconds (mas) full width at half maximum light (FWHM). To avoid telescope jitter corrupting this image, we need to keep guiding errors below about 5 mas RMS. If we choose a value of 3.5 mas RMS to allow for other sources of jitter, we obtain a maximum sampling rate of 40 Hz from Figure 7.5. This rate is sufficient to correct for the low frequency vibration (<4 Hz) of the

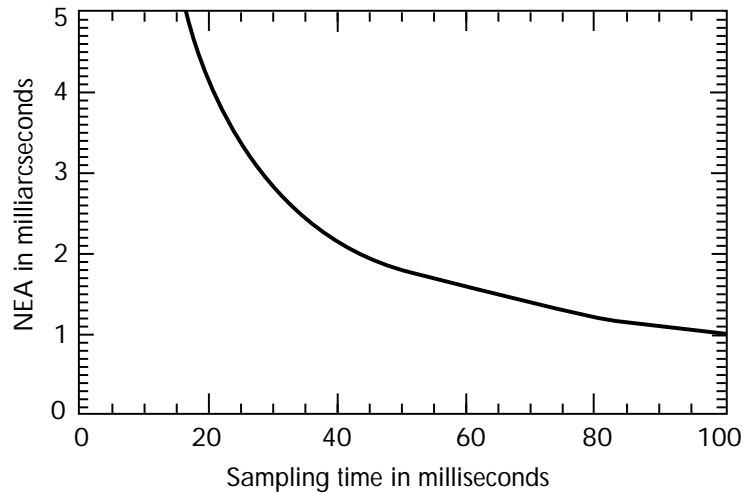

FIGURE 7.5. A K = 16.5 star is sufficient for fine guidance. We assume a 7.2 m primary and 30 e RMS readout noise. (STScI)

deployable telescopes. The Lockheed Martin OTA is more rigid and more forgiving (a fainter guide star could be used).

Fast-Steering Mirror

In the GSFC and TRW SI Module, the corrections from the guiding sensor control a fast-steering mirror located upstream of the science instruments. The mirror is suspended by flexures and is driven in tip and tilt by very reliable magnetic actuators. A typical fast-steering mirror is shown in Figure 7.6. For space applications, the design would include redundant electronics, sensors and actuator coils. Since the mirror is common to all science instruments, it must be extremely reliable. GSFC addressed this issue by mounting a second, fully redundant mirror on the back of the first one. A rotating mechanism will exchange the two mirrors should the first one fail. Lockheed Martin uses individual fast-steering mirrors in each science instrument beam, all slaved to the steering mirror in front of the guiding sensor.

Active Cooling

The NIR camera and detectors can operate at the equilibrium temperature of the passively cooled SI Module, ~ 30 K. At this temperature, the thermal emission of the optics and the detector dark current are

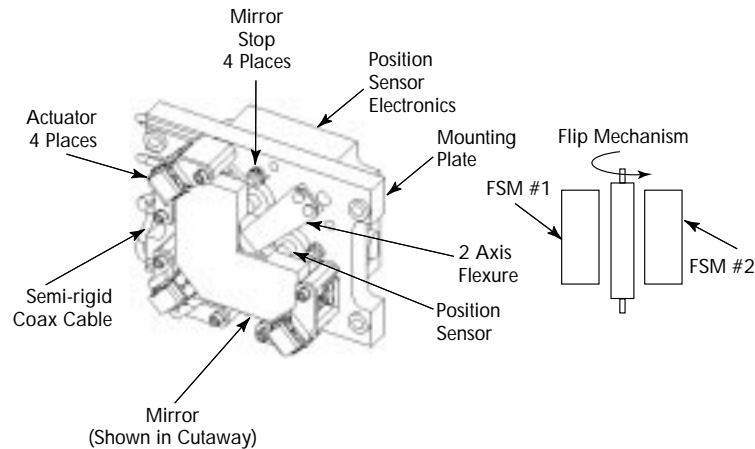

FIGURE 7.6. Typical fast-steering mirror (left). For increased reliability, a second fast-steering mirror can be mounted back-to-back with the first one on a rotating mechanism. (Ball Aerospace)

negligible. For much longer wavelengths, $\lambda \sim 20 \mu\text{m}$, critical elements of the MIR camera and spectrometer must be colder. The filters and entrance stop must be cooled to $\sim 15 \text{ K}$ and the MIR detector to $\sim 6\text{--}8 \text{ K}$ (this presumes that Si:As IBC detectors are selected).

The studies considered several mechanisms to reach these lower temperatures. Stored cryogenics, the method used by IRAS and SIRTf, have unacceptable volume and weight penalties for a 5-year lifetime. Even with the cool SI Module surroundings to reduce parasitic heating, a dewar with a five-year supply of cryogen would weigh 80 kg. Among the possible mechanical cooling systems (H_2 sorption cooler, Stirling cycle, reverse Brayton cycle), the reversed Brayton-cycle cooler is a good candidate because of its moderate power requirement (60 W), low mass ($< 10 \text{ kg}$), high reliability, long life, and very low level of vibration. Unlike reciprocating mechanical coolers, Brayton cycle systems use turbines for both compression and expansion. The turbines have gas bearings and are essentially vibration free. The absence of continuously rubbing parts should reduce or eliminate failures due to wear. Sorption coolers are very promising, particularly for small heat loads.

Calibration

On-orbit calibration will consist of a combination of sky observations and exposures using internal sources. Sky flats (“flat fielding”) serve to check the relative sensitivity of the detectors as a function of field position on a large scale. By observing standard star fields with small offsets between each exposure, we can reference each area on the detector with the rest of the array. More frequent calibration of the detectors on a pixel-to-pixel scale will be performed using a continuum lamp. Spectral calibration will be obtained with a continuum lamp equipped with narrow-band filters which adequate for low-resolution spectroscopy. Dark-current measurements are obtained with a blank (reflective) filter and flux calibrations made with standard sky sources.

The GSFC/Ball Science Instrument Designs

Of the three studies, the GSFC/Ball Aerospace designs of the scientific instruments were most complete. We present them here to estimate the total mass of the SI Module and demonstrate that the instruments can fit within the volume and weight budgets common to all three studies. The GSFC suite of instruments includes high-performance cameras and spectrometers covering the spectral region from $0.6\text{--}5 \mu\text{m}$, with performance extended into the MIR ($\lambda \sim 5\text{--}28 \mu\text{m}$). The instruments

include a NIR camera (actually composed of four subcameras, all identical), a multi-object NIR low-resolution spectrometer, and a combined thermal infrared camera/spectrometer. These instruments can work in parallel and significantly decrease the time required for surveys. In addition, the cameras do not require pointing accuracy better than 1 arcseconds. As mentioned above, a small portion of the NIR camera is the fine guidance sensor for all the instruments.

The NIR Camera

The NIR camera takes full advantage of the high angular resolution of the telescope at wavelengths of $2\ \mu\text{m}$ and above over a wide field of view. The camera uses InSb detectors and is highly efficient in the NIR and red portion of the visible spectrum, $\lambda = 0.6\text{--}5.5\ \mu\text{m}$. To satisfy the need for wide field for guiding and efficient surveys, the GSFC design uses a $4' \times 4'$ field of view. Because of practical limits in detector packaging and the difficulty of building near perfect cameras for so large a field of view, the design uses four identical subcameras, with each covering a field of $2' \times 2'$ (Figure 7.6). Each subcamera uses an Offner relay to transfer the main telescope field onto the $2\text{k} \times 2\text{k}$ InSb detector. The Offner relay provides excellent image quality over the entire field. The focus of each camera is set independently by displacing the small secondary mirror of its Offner relay.

Each subcamera has an independent filter wheel with a dozen different filters. One is a silvered blank and blocks all light from reaching the detector (handy for measuring the dark current and electrical bias). In the GSFC design, five positions in each subcamera use survey filters common to all four subcameras. The six remaining filters are specific to each of the four subcameras (i.e., narrow-band filters, polarimetric filters, etc.). Figure 7.7 shows the filter wheel located near the Offner pupil to minimize its size. A good example of the shortage of volume in the SI Module, the filter wheel must straddle the return beam and have openings to clear it.

NIR Multi-slit Spectrometer

The NIR galaxy surveys and many other NGST science programs require the ability to take spectra of hundreds of objects simultaneously. On ground-based telescopes, this is done by using mechanically or manually positioned optical fibers or precisely cut aperture plates to isolate each target. Alternatively, a dense bundle of fibers can be used to dissect a small portion of the field and arrange it at the entrance of an imaging spectrometer. The GSFC NGST spectrometer uses silicon-based digital micromirror technology developed by Texas Instruments to divert portions

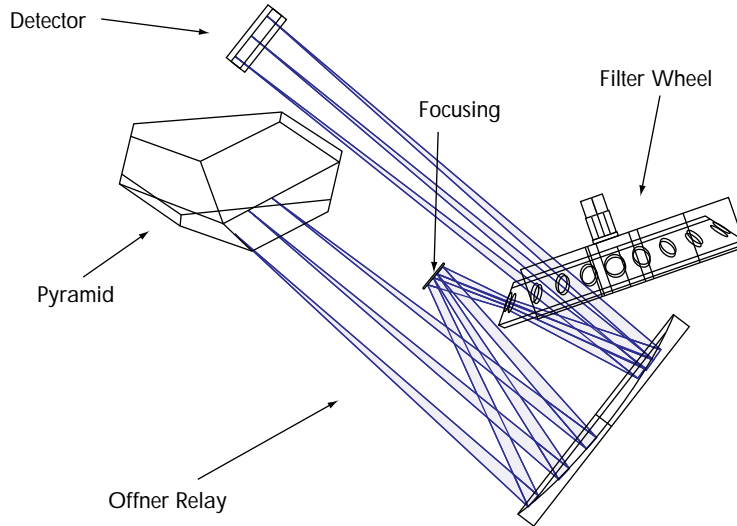

FIGURE 7.7. Optical layout of the near-infrared camera. The beam from the telescope strikes the four-sided pyramid and is sent to four identical subcameras. The large Offner optic is approximately 0.6 m along the longest axis. (GSFC/Ball)

of a 3' x 3' field into a NIR spectrometer. Each of the 1800 x 1800 micromirrors can be commanded to tilt at ± 20 degrees from its rest position. At one tilt angle, the micromirrors will reflect the incoming beam into the spectrograph, while rejecting the beam at the other angle. Using software tools and an NGST survey image, the astronomer selects hundreds of single slits or apertures of any desired width and length to cover the available field with no overlapping spectra on the 4k x 4k InSb detector. Alternatively the on-board computer can select the brightest sources in the field and arrange the slits autonomously. The angular resolution of each micromirror element is ~ 100 mas. The wavelength resolution is set by the choice of gratings, $\lambda/\Delta\lambda = 100\text{--}3000$. Among multi-slit spectrometers, this micromirror approach is the most efficient because it can arrange single-order spectra onto the detectors in an optimal way. A version of this spectrometer design is proposed for an instrument to be installed in HST in 2002. Figure 7.8 shows a simulated spectroscopic observation of a hundred targets in the HDF using this technique.

The MIR Camera

The MIR camera extends the wavelength coverage of NGST from 5-20 μm , using a 1k x 1k Si:As array. Because the angular resolution is not as demanding in this region, we may use refractive optics to

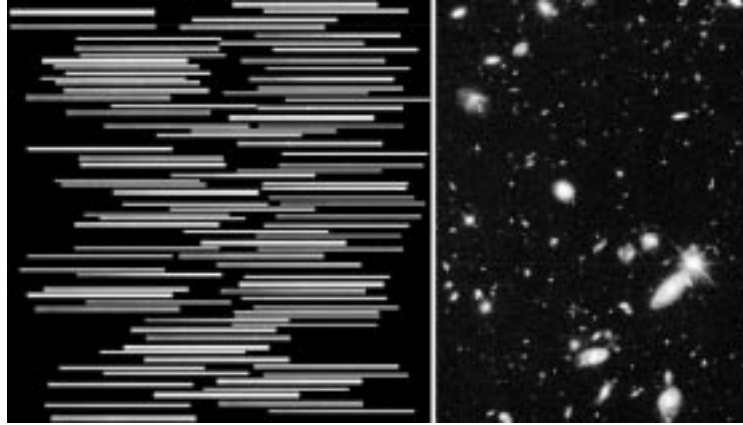

FIGURE 7.8. A simulated spectroscopic observation of the HDF (right panel). The left panel shows a simulated 20 orbit, 0.8–1.6 μm , $\lambda/\Delta\lambda = 300$ HST exposure of the same field with a limiting magnitude of $J_{AB} = 25.1$. The simulation uses the photometric redshift and brightness profile for each HDF target. The NGST multi-slit spectrometer will use a similar micromirror array and achieve an order of magnitude greater sensitivity while covering the spectral range 0.6–5.5 μm . (The MIROS Team/STScI)

obtain acceptable performance over a $2' \times 2'$ field. The optical path is shown in Figure 7.9 and is shorter and easier to package than the NIR reflective subcameras. GSFC/Ball Aerospace designed the MIR camera and companion MIR spectrometer to be simple and low cost. Larger fields of view and higher spectral resolutions can be achieved with increased weight and cost.

The MIR Spectrograph

The MIR spectrometer is a single aperture spectrometer with a spectral resolution of $\lambda/\Delta\lambda \sim 1000$ and a spectral range of $\lambda = 5.8\text{--}21 \mu\text{m}$ (Figure 7.10). It shares the detector and filter wheel of the MIR camera. The cold entrance slit is 0.75" wide and 2" long. Light from the slit passes through a transmission grating and cross-dispersing prism in the filter wheel to create two spectra on the detector, 5.8–13.1 μm and 12.75–21.2 μm .

Structure, Mechanisms and Packaging

The GSFC/Ball Aerospace designers struggled to package the wide field and long focal length NGST science instruments into the allowed SI Module volume and mass limit. They adopted an integrated design to minimize interfaces and reduce the volume and mass. All instruments are attached to a single optical bench, which is connected to the telescope with stress-free mounts.

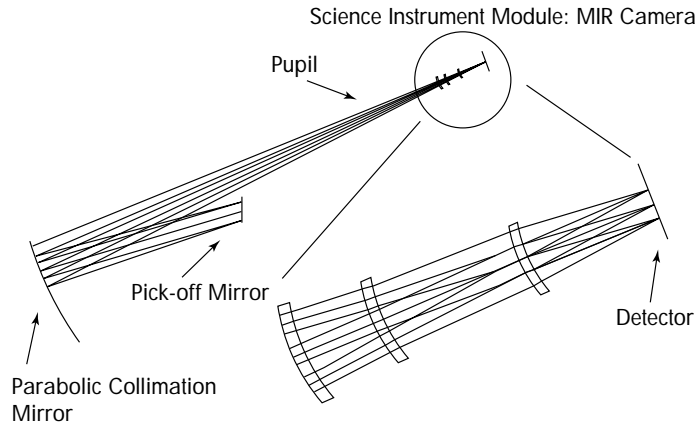

FIGURE 7.9. The MIR channel optics consist of a spherical field mirror, one KBr lens and two KRS5 lenses (different glasses). The field mirror redirects the beam from the telescope focal plane and through a cold pupil stop at the entrance of the cold camera (~15 K). (GSFC/Ball Aerospace)

In the GSFC SI Module, the mirrors, optics mounts, mechanisms and optical bench are all made of beryllium. Beryllium has a very high strength-to-weight ratio. Making all the components out of a single material also guarantees that the optical system will remain in focus over a wide range of temperatures. It also eliminates the need for differential expansion compensation to avoid stressing the optical components during the cool-down period. The overall view of the optical bench is shown in the Figure 7.11.

The bench and instruments are surrounded by an enclosure, which serves as physical, straylight and contamination protection for the science instruments. It also forms a thermal barrier against radiation from the back of the sunshield. The enclosure has no physical contact with

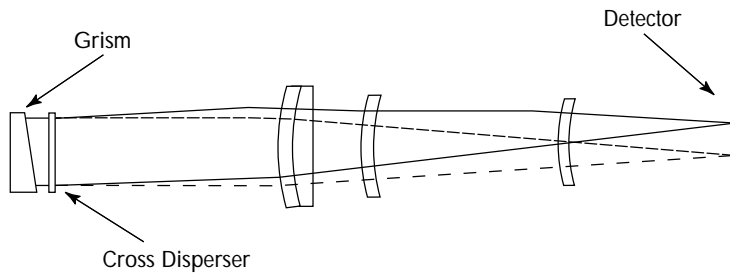

FIGURE 7.10. Optical layout of the MIR spectrograph. (GSFC/Ball Aerospace)

the optical bench and is supported by the OTA attachments fixtures used for the optical bench.

Required Technological Development

For the most part, we can design and manufacture the science instruments using well-established designs and proven techniques. However, three technology areas are vital to the science mission and required additional development: detectors, multi-object spectrometers and low-temperature operation. In addition, we may require an active cooling system to extend the scientific reach of NGST into the MIR.

- Detectors: Today's NIR detectors have performance near that desired for NGST. We will undertake a strong development and prototype program to ensure that the improvement in dark current and readout noise are achieved, and that the packaging of 4k x 4k devices from 1k x 1k elements is well established. For the MIR detector, we will investigate the potential of HgCdTe for acceptable performance at $\lambda < 12 \mu\text{m}$ using only passive cooling to reach 30 K. If this is not successful or if we find that sensitivity to longer wavelengths is required, we will augment the development programs with the Si:As IBC detector to achieve the desired low dark current in a 1k x 1k format.

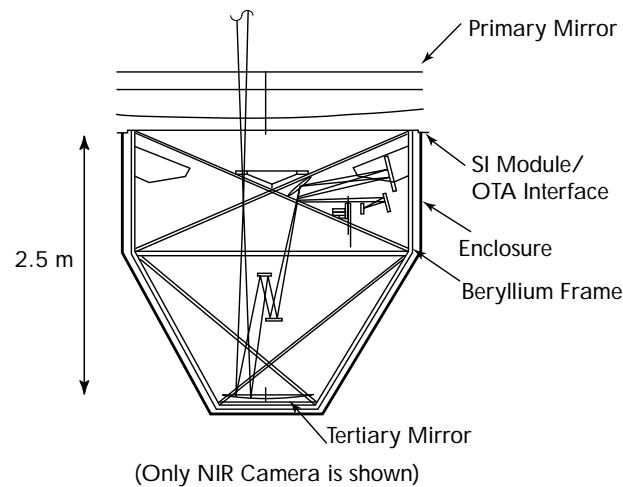

FIGURE 7.11. The SI Module Optical Bench and Enclosure. Note that the tertiary mirror for the telescope is located at the bottom of the optical bench. Neither the telescope beam nor the focal plane pyramid for the NIR camera are coaxial with the telescope. For clarity, we show only one of the four beams for the NIR camera. (GSFC/Ball Aerospace)

- Multi-object Spectrometers: All three study teams are excited by the potential of the digital micromirror arrays for multi-object spectroscopy. We must evaluate the feasibility of using or modifying this technology for use at low temperatures. If needed, we will also investigate the use of dense-pack fiber bundles at cryogenic temperatures.
- Cryogenic Temperature Operation: Although many space science instruments have operated at cryogenic temperatures, none had the complexity of the NGST SI Module. We must ensure that mechanisms, materials and electronics work in the 30–60 K range before proceeding with final design. In particular, we must evaluate the reliability and performance of stepping and DC torque motors, flexures, actuators, hinges and latches at these temperatures. As part of the overall NGST technology-development program, we will obtain the fundamental properties of composite materials and metals. Processes for joining different materials will be investigated and developed.
- Active Cooling Systems: The most promising closed-cycle systems, the Brayton cycle cooler and H₂ sorption cooler, appear capable of cooling the MIR detector (2 mW at 6 K) and an active development and flight validation program should be pursued.

CHAPTER 8

The NGST Spacecraft Support Module

THE NGST SSM, as its name implies, provides essential services, such as power, communications and environmental control, as well as structural integrity during launch. In many satellites these functions are more challenging and costly than those of scientific or special missions. As a result, the SSM is often called “the spacecraft” or “bus,” while the science instrument is called the “payload.” To avoid confusion, we always refer to the elements that provide these crucial support services as the SSM, although they may be distributed throughout the satellite.

We organize this chapter, which describes the SSM designs for the three team concepts, in terms of the critical support functions and the variety of options available to the designer. We begin with those related to the basic mechanical design of the satellite; structure and launch support, contamination control and thermal control. We also discuss the SSM itself. It is responsible for maintaining the overall spacecraft attitude and station keeping. Finally, we highlight the electrical services: command and data handling, communication, and power.

Structure and Deployment

The structural elements of the SMM must withstand and mitigate the stresses of launch. They also must provide a stable and rigid platform for the NGST SI Module and OTA. The chief design challenges are minimizing volume and weight, and providing reliable deployment mechanisms. All three study teams utilized modern composite materials, such as carbon-fiber-reinforced resins, to provide the greatest strength to weight. The teams differed in their selection of deployable mechanisms.

The Lockheed Martin concept minimizes deployable structures and its SSM is no exception. The SSM is part of the rigid OTA support structure and has a high fundamental frequency, greater than 20 Hz for the

entire SI Module and OTA. The sunshade is also rigidly attached to the SSM. Together their mass is 500 kg, a large portion of the available mass budget. The solar array support is the most significant deployable element under the Lockheed Martin plan. It deploys to the aft of the main telescope to balance solar radiation forces and to reduce the thermal heating of the OTA.

Both the GSFC and TRW concepts use small core elements to provide launch support for the SI Module and OTA and to house deployable sunshields and thermal isolation masts. All the SSM elements must be accommodated within a third of the modest Atlas IIAR fairing volume to allow sufficient space for the SI Module and deployable primary mirror. The TRW SSM and the sequence of deployment are shown in Figure 8.1. After separation from the launch vehicle, only the gimballed antenna and bus-mounted solar panels are initially deployed. One month later, the thermal isolation mast is deployed to separate the warm portion of the SSM from the SI Module and OTA. This mast is based upon the successful Astromast design. The sunshield is deployed after the primary mirror and secondary mirror structure deployment. The TRW sunshield is deployed by mechanisms that first unfold arms and then use cables to pull out sheets of flexible multilayer insulation. The TRW team chose this approach because of its extensive experience with mechanical deployment in space. The sunward side of the shield also supports amorphous

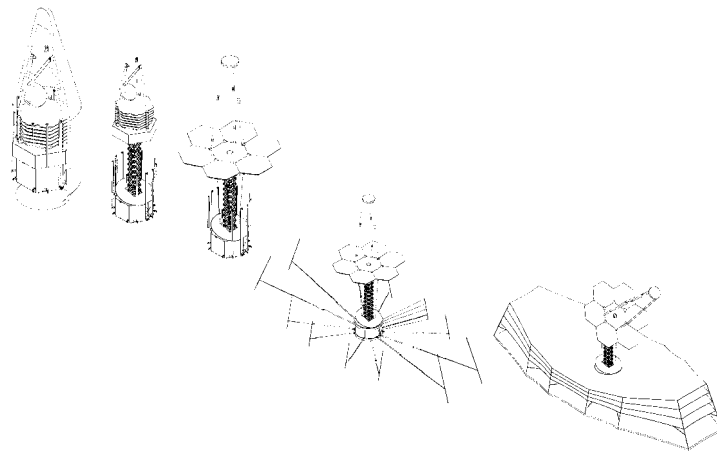

FIGURE 8.1. The deployment sequence for the TRW NGST concept. After the shroud is ejected, the order of deployment is: 1) extension of the thermal isolation mast; 2) deployment of the optical telescope; 3) extension of the sunshield supports; and 4) unfurling of five flexible shields. (TRW)

silicon photovoltaic arrays for generating electrical power and electrochromatic arrays for controlling radiation torques.

A novel primary feature of the TRW concept is the ability to adjust the pitch angle between the telescope axis and the sunshield and SSM. Motors and harmonic drives in the warm SSM are connected by cables to the gimballed telescope. This feature provides observational access to a full celestial hemisphere opposite the Sun. It also reduces the size of the sunshield compared with the GSFC sunshield. The GSFC design has a fixed angle between the telescope axis and the sunshield. As a consequence, the sunshield is made larger to permit larger deviations from the sunline and better sky access (e.g., Figure 2.6). This choice—fixed-telescope axis versus adjustable-telescope axis—will be made by comparing overall performance with cost and reliability.

The GSFC deployment sequence is shown in Figure 4.8. After the Centaur upper stage has directly inserted the NGST toward the L2 point, the SSM core structure is separated from the SI Module and OTA by the deployment of a 5 m isolation mast. After the mast is fully extended and locked, the large sunshield is extended by the inflation of several flexible tubes (Figure 8.2). These tubes are made of Kapton-reinforced aluminum foil, which becomes rigid after inflation. The sunshield is made

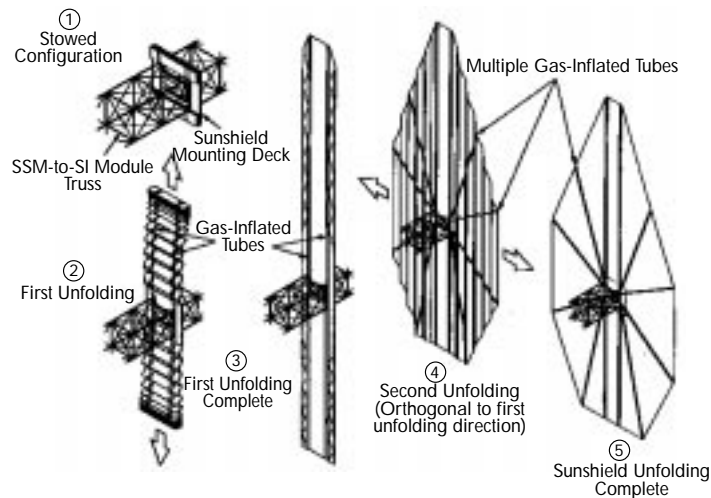

FIGURE 8.2. The GSFC Inflatable Sunshield. The deployment of the inflatable sunshield is shown from left to right. The gas-inflated tubes become permanently rigid after they are completely extended. (NASA/GSFC)

of four parallel layers of silver-coated Teflon material. The final deployment step is to unfold the omnidirectional antenna and a boom that supports one of the station-keeping thrusters.

Contamination Control

Given the long mission lifetime and the very low temperatures in the SI Module and OTA, we must be concerned about molecular contamination of NGST optical surfaces. Because it works in the NIR and not at ultraviolet wavelengths, NGST is less affected by thin coatings of water or molecular films than is HST. However, exposure to sunlight during deployment, which can darken thin chemical films, or the gradual buildup of several hundred atomic layers of water or hydrocarbons on cold surfaces can seriously degrade the telescope's performance. The primary sources of contamination after launch are the propulsion system, gases escaping from the structure and electronics in the space vacuum, and particles released by flexing and rubbing during deployment. The latter sources can be controlled by careful design and cleaning and baking components before assembly. The three teams developed different strategies to eliminate contamination by spacecraft fuel.

In the Lockheed Martin concept, no station-keeping or additional momentum is required after direct injection into the 1 x 3 AU elliptical orbit. Non-contaminating, cold-gas thrusters are used to counteract the cumulative effects of the solar wind and radiation torques. The only deployable structures, the high-gain antenna and solar array, are mounted behind the primary mirror. In the TRW concept, the primary mirrors remain stowed and protected in their launch configuration for one month after launch. During this period, the NGST is in its lunar phasing orbit, and bipropellant thrusters are used for orbit-correction burns. Any contaminants eventually evaporate from the outer spacecraft surfaces. After the last firing of the bipropellant thrusters, the insulating Astromast is extended and the primary and secondary mirrors are deployed. The mirrors are judiciously warmed by sunlight to drive off any remaining hydrocarbons and water. Finally, the sunshades and thermal shields are deployed and the OTA and SI Module are cooled to their operating temperatures. Station-keeping propulsion uses non-contaminating compressed H₂ gas.

The up-down deployment scheme in the GSFC design faces a potentially serious contamination problem because the lower, outward-facing mirror surfaces are exposed to sunlight shortly after launch and may be darkened. Therefore, the GSFC team is considering the addition of a contamination cover that will be ejected only after the thermal mast and sunshield are deployed. To minimize contamination by spent propellants, all

of the thrusters in the GSFC NGST are on the sunward side of the sunshield. Since spent or unburned propellants travel in ballistic paths in space, the shield protects the primary and secondary mirrors and the SI Module from molecular contamination.

Thermal Control

The SSM thermal system must handle two very different temperature regimes. The OTA and SI Module operate in the 30-50 K range, and the electronic and propulsion units in the SSM prefer temperatures nearer room temperature, 230-270 K. The latter range is typical of most spacecraft and can be maintained with careful thermal design and, if required, heaters, louvers and heat pipes for thermal control. Maintaining the low OTA and SI Module temperatures is a more significant challenge. In particular, thermal conduction and radiative heating of these surfaces by the warm SSM and large sunshield must be kept very low, less than one watt. The TRW and GSFC concepts reduce conductive heating by using a thermal isolating mast to separate the SSM and SI Module or OTA. The TRW Astromast is made of T300 graphite and conducts less than 0.1 watts to the OTA; the GSFC mast is made of gamma-alumina and has similar performance. The two concepts employ similar solar shields. The sunward layer must be sturdy and reflect the entire solar spectrum. The inner shields channel the IR emission from each preceding layer away from the telescope. In the TRW design, the shield is composed of an outer layer of 0.001 cm silvered Teflon and four radiation layers of thinner mylar separated by 5° angles and coated with aluminum on both sides. Even with five radiation shields, the temperature across the primary mirror varies significantly throughout the 90 degree pitch angle range. The GSFC concept utilizes a four-layer sunshield. Initial thermal models predict that the primary mirror temperature will be in the 40-60 K range. To provide working temperatures of 6-8 K for the MIR detectors, the GSFC concept includes active cryogenic cooling. A reverse Brayton Cycle cooler circulates helium gas that cools the MIR detectors to approximately 8 K. Most of the mass and power dissipation in the cooler resides in the SSM. Additional radiative cooling of the helium gas occurs along the isolation truss.

The chief challenge for thermal control in the Lockheed Martin concept is the wide range in solar heating. In the 1 x 3 AU orbit, the solar heating changes by a factor of nine. With 22 layers of multilayer insulation (MLI) on the fixed sunshield and additional thermal insulation on the back of the primary mirror, the thermal modeling in this concept predicts mirror temperatures of 50 K at 1 AU and 35 K at 3 AU. The lower mirror temperature (near 3 AU) reduces the MIR radiation from the telescope

optics during the portion of the orbit where the zodiacal background is the lowest. The Lockheed Martin concept employs no active cooling.

Propulsion

Spacecraft propulsion systems typically have two functions; to make mid-course and periodic orbital adjustments and to remove angular momentum acquired by various external torques (e.g., radiation pressure). Orbital adjustments are needed on time scales of months, but significant angular momentum can build up in less than a day. In the latter case, the spacecraft attitude is maintained by spinning massive reaction wheels, which have limited capacity. Satellites in LEO can use magnetic effects to reduce angular momentum and reduce the wheel speeds. At HEO and beyond, the solutions are either propulsion systems or managing the solar radiation torques.

The Lockheed Martin design only requires a cold gas system for unloading angular momentum. The launch vehicle places the telescope into a 1 x 3 AU orbit and no additional maneuvers are required during the mission. By firing cold gas thrusters once a day, the spacecraft can unload the reaction wheels. The amount of gas required is modest and does not limit the mission lifetime.

The GSFC and TRW NGST concepts require mid-course corrections to place the telescopes into orbit about the L2 libration point and for station keeping. The TRW design uses lunar phasing to reach L2 and incorporates two separate propulsion systems to provide adequate thrust for orbital insertion and three-axis control during the pre-deployment mission phase. An efficient N_2O_4/N_2H_4 bipropellant engine produces sufficient thrust for orbit transfer and correction. Four canted N_2H_4 (hydrazine) monopropellant thrusters are used for 3-axis control during burn and coast periods. After reaching the L2 orbit, the TRW design features four canted non-contaminating H_2 resistojets for station keeping. These are mounted near the center of gravity on the thermal isolation mast. The TRW design manages radiation torques by electrically controlling several reflective surfaces ("electrochromic devices") on the sunshield. Therefore, it does not require a propulsion system to reduce the reaction wheel speeds.

The GSFC concept uses a simple N_2H_4 propulsion system for mid-course corrections along the transfer trajectory to L2, for station keeping in the L2 halo orbit, and for managing reaction wheel speeds. As noted in the contamination control section, the GSFC design uses the large sunshield to protect the OTA and SI Module from contamination by the propulsion system. By placing all thrusters on the sunward side of the shield, we must solve the problem of thrusting toward the Sun without

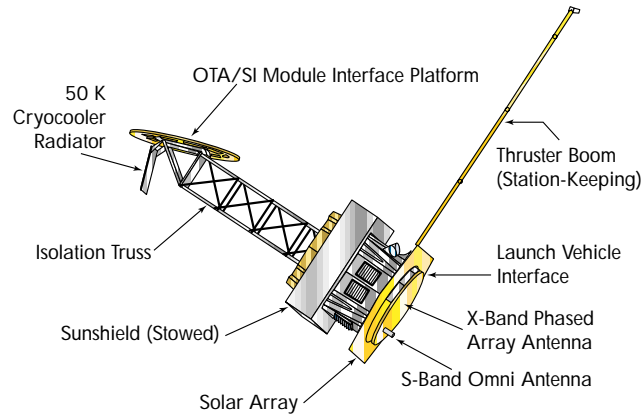

FIGURE 8.3 The GSFC SSM with deployed thruster boom and isolation truss prior to sunshield deployment. The fixed solar array and antennae are placed on the sunward side of the SSM structure. (NASA/GSFC)

exposing or heating the OTA and SI Module. One solution utilizes a long, deployable boom for one of the bipropellant thrusters. The other thrusters are mounted on the warm SSM. With this thruster configuration and varying pitch and roll, the spacecraft can thrust in any direction while still keeping the telescope in shadow. The boom length is chosen to make the thrust vector pass through the center of mass. The GSFC SSM with deployed thruster boom and isolation truss is shown in Figure 8.3. The SI Module and OTA are not included for clarity.

Attitude Control

Three-axis attitude control is traditionally one of the most costly and most difficult spacecraft capabilities. However, for normal housekeeping maneuvers (sun acquisition, safehold, antenna guiding) and moderate pointing accuracy (a second of arc or 5×10^{-6} radians RMS), we can use readily available spacecraft components and control systems. Achieving HST-like pointing performance of 0.007" RMS is another matter. Each of the three concepts uses star fields in the NGST focal plane as the ultimate pointing reference. Since even these beacons cannot compensate for very rapid jitter, the entire optical system must be highly isolated from vibrations and other disturbances. Fortunately, the L2 and 1×3 AU orbits are relatively free from external forces. The culprits are more likely to be reaction wheels, active cryogenic cooling systems, thermal disturbances and the inevitable noise in the attitude control system.

The Lockheed Martin concept uses a traditional attitude control system: a 3-axis star tracker, plus four gyros and four reaction wheels, both sets arranged in redundant (three of four) tetrahedral configurations. With the stiff Lockheed Martin telescope structure (>20 Hz fundamental), the control system can use a 1 Hz control system bandwidth to achieve 0.05" RMS pointing accuracy. By using a fine guidance sensor (FGS) in the NGST focal plane, the Lockheed Martin design can provide 0.006" RMS stability. The dedicated FGS tracks a star image on a 4k x 4k detector array(s) and uses this information to provide 30 Hz bandwidth control of small steering mirrors in the SI Module. HST uses a very similar attitude control system except that the attitude of entire OTA (and spacecraft) are controlled by the FGS rather than small steering mirrors.

The TRW design uses three different processes for science pointing. First, the telescope elevation relative to the sunshield can be mechanically adjusted in 5° steps. The next two levels of control are similar to the Lockheed Martin design: redundant reaction wheels and star trackers to achieve 60" RMS attitude control of the SSM; and a focal plane FGS controlling a fast steering mirror. The two FGS cameras (4k x 4k pixels each) provide a 8' field of view and 0.006" RMS stability. Coarse attitude control for Sun acquisition, thrusting, and contingencies is provided by a combination of ground tracking, coarse sun sensors and hemispherical resonating gyros. As noted above, the TRW concept manages the solar radiation torques by electrically controlling the reflectivity of large portions of the sunshade. The radiation pressure from a reflective surface is greater than that from an absorbing and reradiating surface. Moreover, by deforming the sunshield using controllable struts, the TRW concept can eliminate the buildup of roll (spin) momentum.

Similar to the Lockheed Martin design, the GSFC concept uses traditional components such as star trackers, gyros and reaction wheels to achieve 2" RMS absolute pointing control for the spacecraft and telescope. However, unlike the stiff Lockheed Martin structure, the GSFC structure is relatively flexible and requires a sophisticated system of vibration control to achieve 0.005" RMS fine pointing jitter performance. In particular, the truss, SI Module and OTA are attached to the SSM and sunshield through low-bandwidth magnetic couplers (voice coils). High-frequency vibrations from the SSM are not transmitted to the OTA. The voice coils maintain the relative pointing of the SSM and OTA to arcsecond accuracy over time scales of many seconds (0.01 Hz). The NIR science camera, which has a field of view of 16 arcminute², controls the fast-steering mirror at higher frequencies (30 Hz) and much lower angular amplitudes. We show the schematic transition between control by the SSM star trackers (1" RMS at 0.01 Hz) and the control by the FGS or science imager in Figure 8.4. The key performance goals of the isolation and control elements are:

- 1) the science imager must eliminate the slow drift in the SSM startrackers with less than 0.1% residuals (60 db) at 0.01 Hz to produce <math><0.005''</math> RMS jitter in the image over these time scales.
- 2) the isolation system between the SSM and the telescope must attenuate any vibration at frequencies above 1 Hz where resonances occur in the OTA structure (less than 0.01% feedthrough).

The GSFC design meets these goals by using large-format imagers to ensure that bright stars are available for guiding and by a clever design of the mechanical and cabling connections between the SSM and the thermal isolation truss. Another solution is to isolate or eliminate all sources of high-frequency vibrations, such as the reaction wheels.

Process Control and Communications

The Command and Data Handling (C&DH) system manages all the processes and information flow within the spacecraft. A closely related

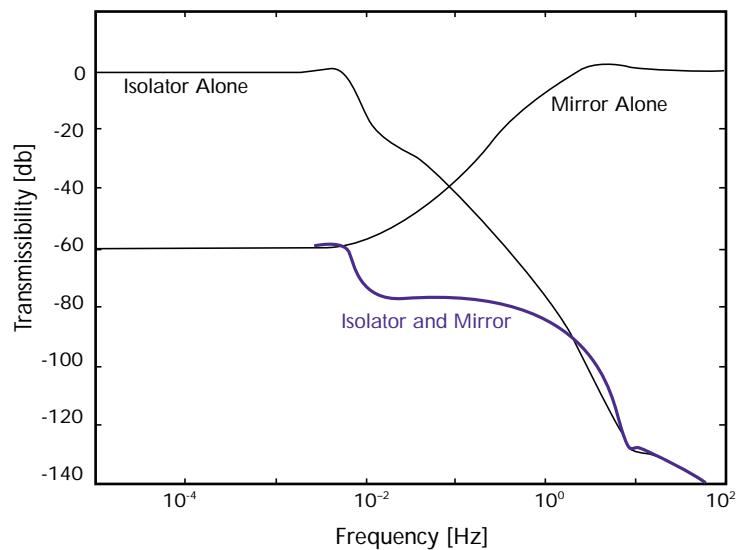

FIGURE 8.4. The influence of active isolation and fast mirror corrections in the GSFC attitude control system. Startrackers provide 1 arcsecond stability for the SSM on long-time scales and active isolation removes high-frequency vibration above 0.01 Hz. The fast steering mirror stabilizes the image field for frequencies lower than $1/10^{\text{th}}$ the sampling rate or <math><4</math> Hz. (NASA/GSFC)

function of the C&DH is handling the communication traffic with the supporting ground stations. Within the C&DH, a variety of processors and data buses may link and control the spacecraft support functions and the science instruments. Much of the work of the central processor in older spacecraft is now done by independent microprocessors that are packaged within spacecraft hardware such as gyros, heaters, power control systems, etc. For NGST, the principal design challenge for the C&DH is the large number of detector elements (approximately 1×10^8 pixels) and the short time in which these elements must be read and their data processed and stored ($\ll 10^3$ s). In Table 8.1, we show the estimated number of science pixels and processor speeds for the three NGST concepts. The TRW and Lockheed Martin designs utilize 20 MIPs processors (millions of 32 bit instructions per second). The GSFC design calls for a pair of more advanced, 100 MIPs processors. Such computers are readily available for commercial use, but have not been developed in a configuration that is reliable in a high-radiation space environment. We anticipate that steady advances in space-qualified processors will continue and 100 MIPs processors will be available by the start of NGST development. In practice, several identical processors may be used on the spacecraft: one will handle control functions and the other science. This would provide important redundancy and, because the control functions are not demanding, additional capacity for error checking. Alternatively, the control computer might use slower but fewer radiation-susceptible components that share the same instruction set and operating system.

The science data rates also drive the need for wide-bandwidth telemetry and large data storage buffers. We can estimate the data volume by assuming that the data value for each pixel is transmitted to Earth every 10^3 s. Using Table 8.1, we obtain a rate of approximately 1.6 Mbps for uncompressed 16 bit data values. In the Lockheed Martin concept, the data frames are added together on time scales of 10^4 s and are compressed to an average of 8 bits per pixel. Using a 5.2 Gbyte solid-state recorder, the spacecraft can continuously maintain a 150 kbps downlink with a 24-hour buffer. The larger storage buffers employed

TABLE 8.1. Processor and Storage Requirements for the Three NGST Concepts

	Science Pixels	Processor Speed (millions)	Processor Type (MIP)	Onboard Storage (Gbits)
Lockheed Martin	60	20	RAD6000	5.2
TRW	106	20	RH32	100
GSFC	100	100 (x2)	TBD	80

TABLE 8.2. Science Data Transmission Rates for the Three NGST Concepts

	Transmission Rates (Mbps)	Frequency	Spacecraft Antenna Dia. (m)	Ground Link Antenna Dia. (m)
Lockheed Martin	0.15 (@3 AU)	X-band	2.5	70
TRW	10	X-band	1.3	11
GSFC	1.6	X-band	Phased array	11

by the GSFC and TRW concepts can hold 24 hours of individual 103 s frames and transmit them in less than an 8-hr contact period without further addition and only moderate data compression. For NGST image data, we anticipate that data can be compressed in volume by factors of 2 and 3 without noticeable loss in scientific quality. Table 8.2 shows the transmission rates and antennae sizes required for the three different concepts. All three concepts use low-bandwidth, two-way telemetry channels (1–16 kps) with omnidirectional antennae for commanding, engineering telemetry, and ranging in any safe attitude. They also would trigger repeat transmissions if science downlinks were corrupted.

Power

The heart of any spacecraft is the electrical power system. It must generate, store, condition and distribute electrical power to each of the major spacecraft functions. Because power is vital to the overall performance of a spacecraft, the power system must be robust and redundant. Even rare anomalies, such as internal shorts or battery-cell failures, must not be permitted to cripple the entire mission. For NGST, the power system is not unusually challenged. Nevertheless, some important innovations distinguish the NGST power systems from current day satellites. Chief among these is the use of highly efficient GaAs and GaAs/Ge solar cells (>20% efficiency). These cells provide much higher power per unit mass and area. Since all three NGST designs are constrained by low launch-weights, the lower-mass solar array technologies are important. The Lockheed Martin concept also must handle the loss of solar power and array temperatures due to its increased distance from the Sun. The latter effect at 3 AU causes the array voltages to increase significantly. To optimize the array power for the standard 28 volt DC spacecraft bus, the Lockheed Martin engineers have designed a special switch yard for combining the elements of the solar arrays.

TABLE 8.3. Power Systems for the Three NGST Concepts

	Array Capacity (watts)	Array Type	Array Size (m ²)	Battery Storage (hour)
Lockheed Martin	700 (@3 AU)	Deployed GaAs/Ge	35	1.5
TRW	3000	Deployed GaAs + amorphous Si	7 + 12	2
GSFC	1200	Fixed GaAs	6	2

Even so, they must employ a very large solar array ($>35 \text{ m}^2$) to generate 700 watts from the low solar flux at 3 AU. The other NGST power requirements are not exceptional. In particular, since the NGST is never in the shadow of the Earth or other bodies, battery power is not routinely needed. Each mission uses a modest battery system to power the spacecraft during launch and initial solar array deployment. For instance, the GSFC concept uses a 17 kg Li-ion battery for the first two hours following launch. These are very efficient, but are not suitable for repeated charging and discharging. The power system for the three concepts is summarized in Table 8.3.

Readiness

The NGST Study team considered only three SSM elements to be on the critical path to mission readiness. These are the large sunshields for the TRW and GSFC concepts, the low-frequency attitude control and isolation system for the GSFC concept — perhaps the TRW design as well — and the electrochromic reflectors used to manage radiation torques in the TRW design. The support functions in the Lockheed Martin concept are challenged by the low power and distant communications in the 1 x 3 AU orbit, but are otherwise straightforward. The technology roadmap (Chapter 10) addresses the development of all three critical elements. While the attitude control and electrochromic reflectors can be adequately tested and qualified for space on the ground, we think that a large-scale model of the sunshield must be deployed in space. One of the NGST precursor missions likely will be a shuttle experiment involving the deployment of either an inflatable shield or one deployed with masts and wires.

CHAPTER 9

Operating and Using NGST

NGST IS AN OBSERVATORY for the astronomy community worldwide. In the tradition of facility-class NASA missions, it will serve general observers using competitively awarded observing time for varied science objectives over a projected five to 10 years. Over its lifetime, thousands of scientists will make NGST observations and hundreds more will recover and use data from the NGST archive. The multi-year mission will support research that builds upon previous NGST observations and discoveries made by other spacecraft and ground observatories.

The cost to operate NGST represents a significant portion of the NGST life cycle budget. Consequently, our concept studies emphasize the importance of affordability and reliability. Two operational themes are common to all the studies and reflect the evolving paradigm for commercial and federal spacecraft operations. First, synergism — working toward common goals using common tools — is essential among the observatory's operators, operations developers and flight-hardware designers. Second, advances in systems for software development and the automation of operations are reducing development costs and making spacecraft more reliable.

We define NGST operations to include all aspects of the observatory that affect, guide, enable or limit the scientist's or engineer's access to NGST data. This scope includes all flight-system and ground-system software, the techniques and frequency of flight/ground interaction and the balance between autonomous operations and skilled human planning and engineering analysis. In this chapter, we identify concepts and approaches that will make NGST a success operationally. Some of the trade analyses and decisions remain in the future. We now know that many NGST mission attributes will make its operation far less costly to develop and maintain than the operation of the HST. A brief comparison of the HST mission and a generic NGST mission concept is made in Table 9.1.

TABLE 9.1. Comparison of NGST and HST Mission Operations

NGST	HST
Simpler/low cost	Complex/high cost
Orbit away from Earth; fewer constraints and scheduling complexities	LEO; many constraints and scheduling complexities
Loose coupling of activities with time	Rigid coupling of activities with time
Direct communication with ground station	Tracking and data relay satellite system (TDRSS) Communications
Single ground system	Distributed ground systems
Modern flight processors; common language and operating system.	Outmoded, architecturally different flight computers (NSSC-1, DF224)
Preplanned observations	Provision for real-time interaction
Primarily long observations	Mixed observation durations
Small number of instrument modes	100 s of instrument modes
COTS and re-use of existing software	Custom software, processor unique code
Concurrent development, led by prime contractor	Multiple (~9) development teams

Development

Software is the central nervous system of a space mission and the major expense for achieving operations readiness. Fortunately, today's techniques for developing aerospace software are far better than yesterday's and still evolving. These advances are being used in small missions such as Near Earth Asteroid Rendezvous (NEAR), Far Ultraviolet Spectroscopic Explorer (FUSE) and Microwave Anisotropy Probe (MAP), and are directly relevant to NGST. We anticipate future improvements and make flight software methodologies and development environments key elements of the NGST technology roadmap.

- Commercial Off-the-Shelf (COTS) Flight Operating Systems (OS), such as Versatile Real-Time Executive (VRTX) and VxWorks, already have flight applications. Useful future OS capabilities will include file management capabilities.
- High-level programming languages for flight software
- Code written in C++ and other modern languages is far easier to prototype, implement and change than those written in machine-dependent assembly language.
- Automatic code generation from algorithms and logic flow diagrams
- Tools that can translate equations and graphics into code can powerfully hasten the prototyping and test of control algorithms and

other processes. Lockheed Martin is using such a tool to develop flight code for the NASA/Stanford University Relativity Mission.

- Automated population of command and telemetry databases; automated definition/update of telemetry formats
- These development tools can integrate development processes, reduce errors and speed the creation of operational systems. Flight code can be scanned for parameters supplied by commands or data bases, and engineering values sampled on the spacecraft and sent to the ground. Companion tools help create these input/output structures and support their documentation.

In addition to these new tools, we can use new management ground rules to reduce the time and cost to develop, integrate and test the flight and ground systems and staff mission operations. These elements include:

- Early involvement of operations experts in mission design.
- Requirements for the flight system, ground system and operations are defined in tandem. These mission elements are then designed concurrently. Early prototyping of the end-to-end software architecture and critical applications software will increase the robustness of the overall mission design.
- Generous flight processor memory and timing margins The great advances in memory size and processor speed are eliminating the need for labor-intensive and error-prone code optimizations.
- Commonality of processor architecture, software language and code development standards throughout the spacecraft.
- The same advances in memory and central processors allow the use of common design rules. A core group of software developers can cover more software territory during the design and maintenance phases.
- Straightforward adaptation of COTS command and telemetry processing systems (C&TSs).
- Standard, operator-friendly systems, characterized by their power and flexibility, are becoming available. Mission-specific applications are more easily integrated. The C&TS for operations will be developed early, and adapted to the special requirements of spacecraft assembly and testing. The design of subsystem simulators and stimulators will have a life cycle focus. This approach will reduce rework.

“Do it once, with a view toward the mission life cycle.” Our mission studies used varied approaches to implement and cost NGST operations. The GSFC study based its cost estimate on recent mission experiences with X-ray Timing Explorer (XTE) and FUSE, reasonable assumptions about the evolution of the development environment and

the development of science instrument code, and recognizing that existing software systems for scheduling and archiving could evolve or be adapted to NGST. Of the three approaches, the GSFC concept is the most conservative and the most expensive. The approach predicts that it will cost \$50M to develop the complete operations system and \$10M to \$15M each year to fund operations. Advances coming from NGST operations technology — particularly in the areas of spacecraft and ground system autonomy — may further reduce these costs. The TRW and Lockheed Martin studies also included that expectation in their estimates.

Operational Aspects of the NGST Orbit

The key factor that simplifies NGST's operations is the Earth-distant orbit. Such orbits eliminate many timing constraints associated with Earth occultations and the use of shared communication resources (e.g., TDRSS). Periods of uninterrupted target visibility are measured in days instead of minutes. Science exposures need not fit within narrow viewing periods and will compete less for specific time windows. Opportunities for data transmissions (commands and telemetry) need not depend on those of other spacecraft. Data collection efficiencies of 80–90%, vs. 50% in low orbit, become feasible. Most important, we can relax or eliminate the requirement that we execute spacecraft operations at pre-defined times. The combination of high efficiency and relaxed timing constraints provides many opportunities for simple, autonomous operations and simplified planning tasks.

These benefits apply to all of the candidate NGST orbits: the L2 orbit, the 1 x 3 AU solar orbit and the 1 AU drift orbit. Operational factors that will enter formal trade-offs among orbits are summarized in Table 9.2.

The signal travel times to spacecraft in these orbits differ greatly and affect choices in communications protocol and operations philosophy. The long command response times of the more distant orbits will lead the operations concept toward greater flight autonomy than might be implemented for L2. The 1 x 3 AU orbit introduces command and telemetry blackout periods whenever the Earth, spacecraft and Sun are nearly in alignment. Daily communication between NGST and Earth is possible from the nearer orbits using one ground station; near-continuous communication is possible with two, but is not a mission requirement.

Science observations from an L2 orbit are readily supported with modern radio frequency (RF) technology. Spacecraft and ground antennas of modest size and output power will support X-band (8 Ghz)

Table 9.2. Operational Comparison of Alternative NGST Orbits

	L2 Orbit	1 AU Drift Orbit	1 x 3 AU Orbit
One-way communications time	5 seconds	Up to several minutes	Up to 30 minutes
Communications opportunities	Daily	Daily	Usually daily; impacted or absent when Sun is near Earth-NGST sightline
Science data downlink	Straightforward; >1 Mbps easily supported with RF comm.; 10 Mbps achievable	Harder as distance grows; onboard processing, laser comm. possibly needed	Requires special techniques: data co-addition, analysis and compression and/or optical comm.
Station-keeping planning	Several times per year	Not needed	Not needed
Environment and constraints	Stable	Stable	Vary around orbit

downlink data rates in the one-to-10 Mbps range and S-band (2 GHz) uplink rates up to 20 kbs. Telemetry from missions in drift orbit and the 1 x 3 AU orbit is more problematic. These missions will be constrained to RF uplink rates slower by one or more orders of magnitude. To accommodate a similar reduction in the data rate, we must consider additional on-board data processing and compression. In the long run, optical communications technologies — modulated laser light — may be the best option for achieving high data rates at these very distant orbits.

On balance, the L2 orbit is the ideal orbit for operations. The requirement for periodic station-keeping maneuvers at L2 has little impact on operations. The 1 x 3 AU orbit will be the most difficult to support. We believe that improvements in communications and software will make such an orbit feasible if the resulting operational autonomy includes aggressive on-board science data processing.

The Flight System

Spacecraft command and data-handling systems are benefiting from rapid advances in system architectures and computer and storage technology. These improvements will free NGST development from some of the factors that have historically driven up costs, including labor-intensive code iteration and optimization to fit limited flight computer

resources and mission-unique operating systems. All NGST studies assume and use these advances to enable robust flight-system concepts.

The structure and major functions of the NGST flight software architecture are shown in Figure 9.1. In earlier spacecraft, different contractors used specialized software languages and computers to accomplish these tasks. In the future, processor commonality and compatibility will reduce development and life-cycle costs, as will use of a single, perhaps commercial, spacecraft operating system. Future flight processors may support a workstation environment that simplifies flight-code development and its migration from the ground to the spacecraft.

Taking advantage of NGST's Earth-distant orbit, all three flight-system concepts give the spacecraft autonomy over many functions. Event-driven sequential operations (e.g., slews, attitude updates, guide star and target acquisitions) use relative-time commands stored on board. The process to implement observations is fluid. Spacecraft antenna control, maneuver generation and attitude determination and control are autonomous functions. The spacecraft itself will determine when gas jets or other devices must compensate for the momentum produced by sunlight reflecting off the NGST sunshade. One study uses the attitude determination capability of its spacecraft concept to make guide-star selection an autonomous function. We may find that processes to maintain the telescope's image quality are also appropriate for autonomous control.

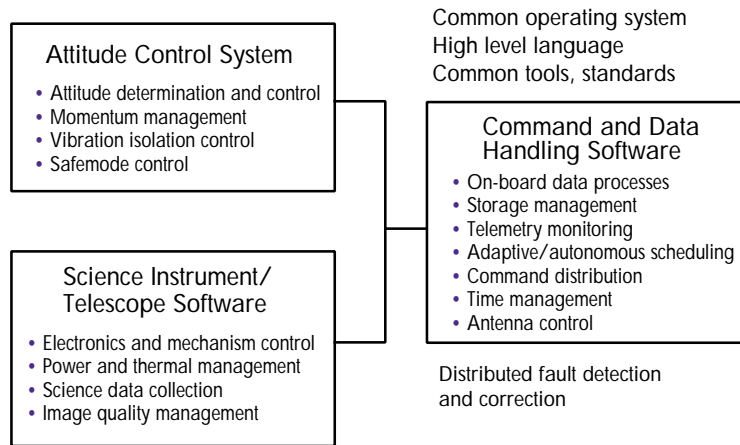

FIGURE 9.1. Flight Software Structure and Functions. Spacecraft such as HST use separate computers and software environments to accomplish these tasks. Modern spacecraft can use common languages and processors. (NASA/GSFC)

The responsibility for controlling the optical performance may change between ground and spacecraft as a function of mission phase, frequency and degree of adjustment.

The GSFC study team refers to its version of NGST flight autonomy as “adaptive scheduling” to denote an event-driven, flexible execution of spacecraft functions. An adaptive scheduling program initiates a sequential activity when the predecessor is completed, manages parallel activities and inserts housekeeping functions when needed. A sequence of pointings and subsequent observations of different targets can be represented by a series of files. Each file specifies the location and particulars of the planned observations. These pointings are easily reordered because files — free of pre-assigned execution times and linkages— are easily added, removed or shuffled.

Other options occupy the domain between moderate and high autonomy. In the GSFC concept, the operations team defines a nominal order for NGST pointings according to attitude constraints and slew times. Last-minute changes (targets of opportunity) are straightforward. The TRW and Lockheed Martin concepts employ more autonomy. Their flight processors do observation sequencing. Ultimately, such techniques could make the spacecraft responsive to signatures it detects in data; e.g., adding exposures in more wavebands if a signal in one exceeds a threshold; or, in survey mode, configuring micromirrors for a spectrograph exposure yielding redshifts of a field’s brightest objects. The NASA New Millennium Program is advancing the concept of remote agents — tools for spacecraft autonomy — in the context of small, low-cost missions. Progress in this arena will be monitored and fostered where it seems especially promising for NGST.

On-board engineering telemetry processing is another area where spacecraft automation and autonomy will reduce NGST life cycle costs. Unlike previous spacecraft that send fixed and very repetitive telemetry to the ground, new software architectures put subsystem telemetry through sieves that eliminate redundant data in the downlink.

All of the NGST concepts describe spacecraft that operate unmonitored for hours at a time. Most telemetry contacts between NGST and the ground station are untended. The spacecraft will detect problems and protect itself. Like other spacecraft, NGST will reduce power to failed subsystems, maintain a safe attitude and provide diagnostic telemetry to the ground. The more autonomous concepts can automatically change to redundant subsystems and resume science observations. This degree of autonomy would be extremely valuable in the 1 x 3 AU orbit.

Our architectures include varied concepts for the on-board manipulation, storage and transmission of NGST science data. Options include applications of lossless or lossy data compression, with and without on-

board processing to add subexposures and eliminate cosmic-ray artifacts. Different mixes of storage capacity, spacecraft antenna power and size, communication protocols and ground station antenna size are viable. On-board co-addition and lossy compression algorithms are economically attractive if the resulting data retains its scientific value. Near the detection limit, the balance between volume reduction and information loss is delicate, and represents a substantial challenge for these approaches. Algorithm studies will be especially important to the system solutions needed for orbits beyond L2.

By way of example, the GSFC operations concept for L2 included these features:

- Support for a data generation rate averaging 425 kbps
- Lossless compression of science data; ~3 to 1 compression ratio
- No on-board addition of subexposures or artifact removal
- Science downlink 8 hours per day (average) to an 11 m ground antenna
- X-band downlink at 1.6 mbps; S-band uplink at 16 kbps
- File transfer protocol
- Phased-array spacecraft antenna
- Thirty hours of on-board science data storage capacity (~50 gigabits)

In this solution, data are read from the science instrument detectors, compressed and stored on-board as observation files. Other operations concepts retain the powerful and proven packet schemes that handle today's spacecraft transmissions.

Whatever the specific approach, emerging hardware and software architectures are expanding spacecraft capabilities and lowering development and lifecycle costs. They will enable an effective, efficient NGST science operation.

The Ground Operation

The primary elements of an NGST ground system are summarized in Figure 9.2. NGST will follow the trend in ground operations toward greater automation and lower staffing. Well-designed, effective, user-friendly interfaces and analysis software will permit staffing requirements to be set by expertise, not repetitive workload. Each of our NGST studies foresees a highly automated routine operation and a small spacecraft operations staff.

The ground station communications are affected by orbit selection, spacecraft antenna size, the choice of RF vs. optical technology, and the overall science data rate. For instance, a dedicated 11 m antenna can support NGST at L2. It is efficient to place a dedicated ground station

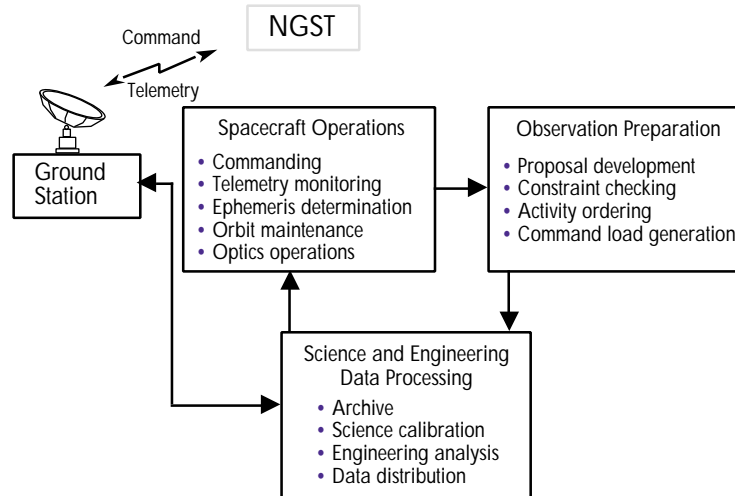

FIGURE 9.2. Principal Ground System Elements. NGST operations includes the definition of mission activities, transmitting this information to NGST, monitoring spacecraft performance, and processing data into science and engineering products. (NASA/GSFC)

with the operations facility, but wherever its location, the station will be fully automated, untended, and remotely controlled from the facility. Daily contacts will be initiated and managed automatically.

Many operations tasks will be highly automated. Traditionally, the majority of spacecraft operations staff received and analyzed telemetry data. For NGST, the long-term trend analysis will establish nominal relationships with engineering parameters (voltages, currents and temperatures). In turn, the established relationships will be the basis for anomaly detection. For an L2 orbit and a single U.S. ground station, telemetry and science data will be exchanged at night. Automated systems will alert staff at their homes (or elsewhere) to anomalies requiring prompt human intervention. Staff and other experts may use analysis tools to query and manipulate datasets from outside the control center. Preparations for special activities (e.g., station-keeping maneuvers or ground-managed optical alignments) will still involve people. Communications resources distributed globally will support the NGST commissioning period and its greater requirement for interaction between the operations team and the spacecraft.

NGST's scientists and operations staff will be fully integrated and will use a common system for generating commands, for both routine and infrequent real-time control of spacecraft hardware. Whether the final

sequence of observations is determined by the ground or the flight system, ground software and staff will ensure the completeness of exposure descriptions, verify their safety and associate each with viable observation dates. Staff will interact with observers to optimize plans or resolve issues.

Science data will be transmitted as compressed files and archived upon receipt. Ancillary files, such as precise pointing information, will be created and archived with the science data. Calibration data will be processed to maintain a history of instrument calibration files. To manage archive volume and reduce reprocessing requirements, we anticipate that science data will be uncompressed and calibrated upon extraction — permitting the best available calibration of a data set en route to the original observer or archive researcher.

The User Interface

Our studies considered several scenarios for user access to NGST, including direct, real-time access to an L2 observatory with a modern version of remote observing. Such an operation is certainly viable, but unlikely to achieve the exposure efficiencies of a facility executing pre-defined observations. We believe centralized consolidation of the total observing program will be more cost effective, serve a broader community and take better advantage of the Earth-distant orbit while accommodating late changes submitted by users. More ground-based observatories use or plan to use similar approaches.

The user interface to NGST is depicted in Figure 9.3. For rapid communications and lower life cycle costs, the NGST user interface concept calls for aggressive use of Web-based tools. We expect the Internet and Web to support and streamline the NGST peer-review process. The astronomical community is already accustomed to computer-aided submission of observing proposals, detailed observing programs and the receipt and analysis of science data. Expert systems assist users in designing and optimizing their observing programs. As a goal, the online tools should assist most observers (>90%) to define and validate their observing plans without staff assistance. Online manuals will provide current information on observatory and instrument performance. Tools will provide target availability, calculate exposure times, prompt users for missing data and measure required time against awarded time. Long-term observing schedules and shorter-term lists of queued observations will be maintained. Automatic electronic mail will advise users of schedule changes and of ground receipt and availability of data.

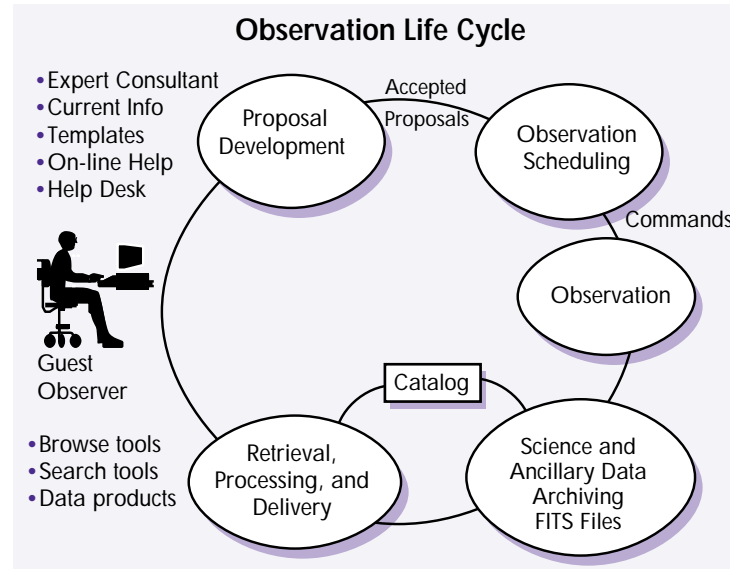

FIGURE 9.3. NGST from a Guest Observer Point of View. A highly automated, Web interface provides users the information and data needed to propose and analyze NGST observations. (NASA/GSFC)

NGST will need a well defined, versatile, yet limited suite of observing options. We believe the concept of observation templates, planned for SIRTf, applies to NGST. Keeping options few in number while ensuring their effectiveness should be a jointly held goal of instrument and operations developers. Our proposed flight software supported NGST science well with only a dozen observing modes. User prompts and automated checks will be readily integrated with template constructs to give scientists instant feedback.

Completion of the observation life cycle will be similarly supported. Modern archival tools (e.g., browse facilities, key words, etc.) will give users access to recent and archived NGST data, and up-to-date calibrations. Advances in network technology will enable electronic distribution of NGST data; in any case, modern high-density media will become more affordable. The archive will maintain an updated calibration history. En route to a user, science data will receive the best calibration associated with its characteristics and date of origin. Users will have the option of receiving raw data, calibrated data, or both.

Steps Along the Way

No large obstacles block the path to affordable and efficient NGST operations. The primary challenges are reducing development and life cycle costs and providing highly reliable spacecraft control and user services. This will be difficult, but NASA and current astrophysics missions are already taking many of the necessary steps. Despite HST's complexity, for example, the HST operations team has significantly reduced costs and has increased effectiveness several-fold since 1990. Explorer missions, such as Extreme UltraViolet Explorer (EUVE) and FUSE, are operated by universities. For NGST, our studies support a consensus approach for developing the necessary technologies. The most important requirement is that the OTA, SSM and science instruments be developed concurrently with the NGST operations. Therefore, operational factors and costs will have a fundamental role in system trades.

The Operations Technology Roadmap fosters modern environments for the creation, test, documentation and maintenance of flight- and ground-system software. Today's environments and approaches are vastly superior to those of a decade ago. We will support work that improves and hones them to our task.

Our feasibility studies explored varied approaches for executing NGST's rich science program. Different degrees of on-board autonomy were invoked. Though the most basic of these adaptive, spacecraft-managed approaches remains undemonstrated in flight software, timely work will enable them. The NASA New Millennium Program will support the development of the remote-agent concepts. The more advanced autonomy requirements of the Terrestrial Planet Finder have generated interest in placing learning capabilities and neural networks in flight software. Technical and scientific trade studies will clarify the level of autonomy that best supports the operation of NGST in its selected orbit.

Reduced operations staffing is a fundamental NGST objective. Our roadmap fosters the identification and development of automation tools that assess telemetry, diagnose spacecraft problems and recommend solutions. We will continue to explore the potential for other AI applications.

User interfaces that effectively service the research community's needs are another focus of the roadmap. The products of this activity are broadly applicable to space science missions; and NGST will benefit from the development of new tools for other NASA science programs, such as SIRTf and AXAF.

CHAPTER 10

Technology for the Next Generation Space Telescope

Advanced technologies are a crucial strategic element in NASA's mission plan for NGST. Based on the findings of three independent study teams, we have concluded that no new invention is required to carry out the NGST mission. A well planned, adequately funded program that allows key laboratory innovations to progress steadily to flight status will provide all the necessary ingredients for an exciting, affordable NGST mission early in the next century.

It is clear that the NGST program will benefit from a number of technological advances that either already exist or are under development at corporate and publicly supported laboratories. Likewise, NGST will advance the state of the art in key technological areas, which will in turn inspire future missions and applications.

This chapter briefly highlights the chief technology challenges or "tall tent poles" that we identified during the NGST Study Integration Process. They are not tied to any individual mission concept or class of concepts, but rather represent a set of technologies that support a wide range of architectures. We suggest that the NGST system architecture studies guide the development of other required mission technologies. Figure 10.1 shows the key technologies that will be important to NGST. Our plan for developing and validating these technologies is illustrated in Figure 10.10, the Technology Development Roadmap. These activities, testbeds, and flight experiments will establish technology readiness and will provide the critical costs and performance information needed to choose the NGST system architecture.

Optical Telescope Assembly Technology

The task of building and launching a 6–8 m diameter telescope, operating at 30–70 K with diffraction-limited performance at 1–2 μm , may appear daunting. This is especially true if we are restricted to using mid-size launch vehicles. An Atlas IIAR launcher, for example, limits the mass of the OTA to <1000 kg. Furthermore, no launch shroud currently exists



FIGURE 10.1. NGST will make key advances in a wide range of space technologies. (NASA/JPL)

for placing a system of this size into orbit in the deployed configuration. The development of a shroud that could place NGST into orbit without large-scale deployments is discussed under "Launch Shroud Technology." In spite of the challenges, we have concluded that a number of technological solutions exist or are emerging rapidly in the critical areas of lightweight mirrors, actuators, active optics and precision structures.

The NGST primary mirror may be composed of multiple 1–3 m segments deployed on orbit. It also could be a 6–8 m monolith if a suitable launcher/shroud combination becomes available. The areal density, including the mirror, its support structure, and actuators (as required), must be $<15 \text{ kg m}^{-2}$ for an 8 m diameter aperture. While this is beyond the current state of the art, we believe it is achievable with logical extensions of current lightweight mirror technology, examples of which are shown in Figure 10.2. The SiC and Be SIRTf prototypes are similar in size and quality to the NGST secondary and tertiary mirrors. Candidate NGST primary mirror designs include:

- 1) lightweight integrated facesheet and core structures fabricated from beryllium, silicon carbide or glass; or
- 2) thin shell structures fabricated from glass, silicon carbide, nickel or composites supported by multiple flexures and/or actuators on a lightweight composite support structure.

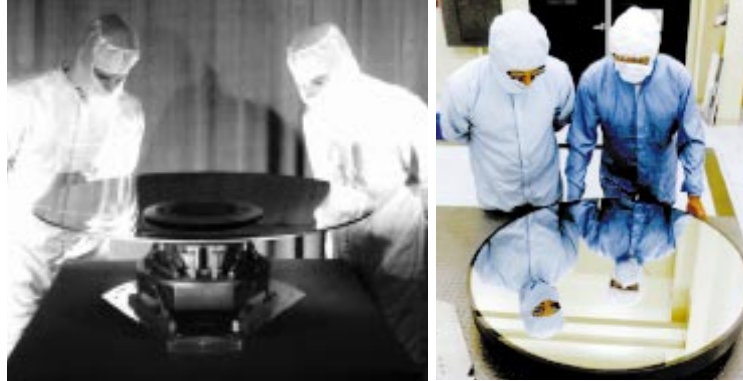

FIGURE 10.2. Left panel: Lightweight 0.85 m cryogenic beryllium mirror for SIRTf; right panel: Closed-back 0.9 m cryogenic reaction-bonded silicon carbide mirror for the SIRTf Telescope Test Facility. (NASA/JPL)

Either of these options could be implemented as a segmented or monolithic primary. We plan to develop and test several candidate technologies through a NASA Request for Offer.

The OTA will incorporate active optical control whether the primary mirror is segmented or monolithic. Cryogenic actuators that can hold their commanded positions without power will provide tip, tilt and piston motions of the primary and secondary mirrors and figure control at the primary or deformable quaternary mirror located in the SI Module. They require 10 nm resolution and 1 mm stroke (length of travel). Such performance is within the current state-of-the-art though not for cryogenic applications. Currently available piezoelectric and electrostrictive ceramics and magnetostrictive materials have greatly reduced performance at cryogenic temperatures. These materials should be reformulated and evaluated for optimum performance at cryogenic temperatures. We plan to pursue such development and testing through a NASA Research Announcement (NRA). We will test them and the software needed to derive the active corrections with a wavefront sensing and control testbed.

The precision structure for the OTA will be fabricated from advanced lightweight materials. If a large diameter shroud is not available, the primary mirror will deploy by unfolding or rotating and locking segments into place. Similarly, shroud constraints may force the secondary mirror to be deployed on an extendible boom, 5–10 m in length. The required deployment accuracy of these structures is determined by the dynamic range (stroke) of the compensating control systems and is generally in the range of 25 μm to 3 mm. One or more precision deployable-structures testbeds, probably existing or constructed in industry, will facilitate

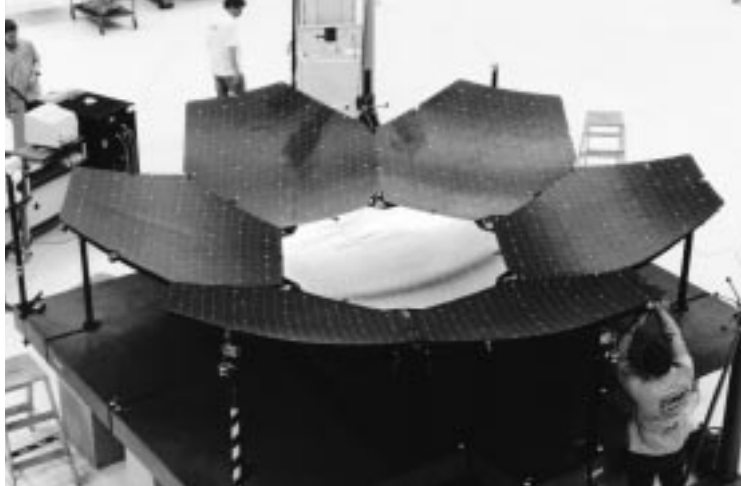

FIGURE 10.3. Top panel: A 4.5 m diameter reflector constructed for the TRW High Accuracy Reflector Development program (HARD). Composed of seven, 2 m hexagonal panels, the deployed reflector has been successfully tested for use at 60 GHz. It has been qualified for missions launched on the Shuttle or a Titan IV. In laboratory



tests, the HARD has achieved deployment accuracies of $18\ \mu\text{m}$. (TRW) Right panel: 30 m-long deployable Fast-Mast flown on STS-46. Over a 10 m boom length, the deployment accuracy would be $\sim 1\ \text{mm}$. (NASA/JPL)

evaluation and demonstration of this critical technology. State-of-the-art precision deployable structures already achieving these levels of accuracy are shown in Figure 10.3.

OTA technology readiness will be evaluated and demonstrated by bringing the various component technologies together in a NGST System Testbed and through Pathfinder Flight Experiments described below.

Science Instrument Module Technology

The SI Module will be a highly integrated package that performs multiple functions including science observations (imaging and spectroscopy), wavefront sensing for telescope alignment and control,

wavefront control (in some implementations) and fine guidance. The science instrumentation will include a visible/near-infrared camera and spectrometer. Inclusion of a MIR camera and spectrometer is highly desirable. Wavefront sensing will be performed by imaging bright stars in the NIR camera and commanding the cryogenic DM to compensate for large-scale aberrations. The same NIR camera may be the sensor for fine guidance on field stars, and autonomous flight software will command a cryogenic fast-steering mirror to remove 0.01–3 Hz jitter.

The SI Module tall poles are the IR detectors, MIR focal-plane cooling and the cryogenic operation of the deformable and fast-steering mirrors. The NIR sensors will require low-noise, large-format (4096 x 4096) detector arrays. Today's state-of-the-art NIR detector arrays (0.5–5 μm) are within a factor of two to four of the required noise performance and have been implemented in 1024 x 1024 format (Figure 10.4). Making larger arrays by mosaics of these devices will be demonstrated soon. Other candidate visible/NIR detectors include silicon CCDs for the 0.5–1.0 μm band and HgCdTe arrays for the 1.0–5.0 μm band.

For the extended MIR capabilities, we require similar large-format (1024 x 1024) arrays and low dark currents. Candidate MIR detectors include HgCdTe in the 5.0–12 μm band and Si:As IBC to cover the entire 2.0–28.0 μm band. The dark current in the long wavelength HgCdTe devices currently exceeds the signal from the zodiacal background. However, we have not reached a fundamental limit in the performance



FIGURE 10.4. Alladin InSb 1024 x 1024 Detector Array. (NOAO)



FIGURE 10.5. Miniature Turbo-Brayton Cooler Components. (JPL)

of these devices, so we anticipate future improvement. The Si:As IBC arrays, similar to those developed for SIRTf, have better performance and are the best choice for the MIR detectors. We plan to pursue NIR and MIR detector development through a NRA, building on existing efforts in support of SIRTf and other applications.

For optimum performance, the NIR and MIR detectors must be cooled to about 30 K and 6–8 K, respectively. Passive cooling should be adequate for the NIR detectors. The MIR arrays require active cooling with expendable cryogenics, such as solid hydrogen or mechanical cryocoolers. Approximately 2 mW of cooling power will be required at 6–8 K. Additionally, the cooler must be reliable over the lifetime of the

mission, and must not vibrate appreciably causing the focal plane to jitter. The miniature Turbo-Brayton cooler (see Figure 10.5), sorption coolers and pulse tube coolers are good candidates. The development of active cooling systems will be shared with other missions, such as the Terrestrial Planet Finder (TPF). Current development programs are underway in NASA and industry which will provide the needed cooler capability.

Deformable mirrors may be used in the SI Module to correct remaining optical aberrations. DMs with the correct size (10–30 cm) and number of actuators (>1000) exist. However, they have not been demonstrated at cryogenic temperatures. Cryogenic-actuator development will be necessary to implement this technology at low temperatures. Candidate actuators include those based on piezoelectric, electrostrictive and magnetostrictive materials. Likewise, cryogenic fast-steering mirrors for fine pointing exist with the required angular range, resolution and bandwidth. To avoid raising the DM and fast-steering mirror temperatures above 30–50 K, the steady-state power dissipation must be low, ~1 mW. The NASA Small Business Innovative Research program is currently funding the development of cryogenic DMs. If required, this effort can be further supported using a NRA.

Spacecraft Support Module Technology

Over the past decade new technologies have increased performance and dramatically reduced the mass, volume, power and cost of key spacecraft components. For example, graphite/cyanate ester composite structures are far more stable and durable than their graphite/epoxy predecessors. Gamma-alumina composite struts and bands provide superior thermal isolation compared with the fiberglass components used on COBE. Gallium arsenide and multi-junction solar arrays are far more efficient than previous-generation silicon arrays. Advanced flight computers, solid-state memories and other flight electronics are smaller, lighter and far more capable than those designed for HST. The SSM will take advantage of these new spacecraft technologies as well as those from commercial satellites, the NASA New Millennium and MDEX program and other technology developers.

A key element of current NGST concepts is a large (10 m x 30 m), light-weight (~100 kg) sunshade that shields the OTA and the SI Module from solar radiation and allows them to cool below 60 K. Various thermal and structural design options exist. If a powerful launcher and large shroud are available, then a fixed shade similar to that used by SIRTf is adequate. If the NGST primary mirror is deployed, then a foldable, deployable shade will be necessary using coated polymeric membranes (similar to MLI) for shielding. Deployment of the shade may be by mechanical means similar to the deployment of large-mesh antennas or by inflation of a support structure. The Inflatable Antenna Experiment, which recently flew on a Spartan spacecraft, demonstrated inflatable deployment of an ultralight-weight, 15 m diameter membrane reflector with three 30 m struts. NASA is currently pursuing efforts in materials development, deployment control and rigidification techniques for inflatable structures that will provide the necessary technology for the an inflatable sunshield. The first Pathfinder flight experiment, the Inflatable Shield In Space (ISIS) will test techniques that make large space-inflatable structures rigid — a requirement for an inflatable NGST sunshade (see Figure 10.6).

Thermal and mechanical disturbances on the SSM cannot propagate to the OTA and the SI Module. This can be accomplished by separating the SSM from the OTA/SI Module with an isolation truss. The SSM will be on the warm side of the sunshade, and thus will be thermally isolated from the cold OTA/SI Module. High-frequency (>1 Hz) mechanical disturbances from reaction wheels or other noise sources can be eliminated with a combination of passive and active vibration control. Active vibration control is being developed for the SIM (see Figure 10.7). Low-frequency disturbances, if they are not too large, can be eliminated with the fine-guidance control system.

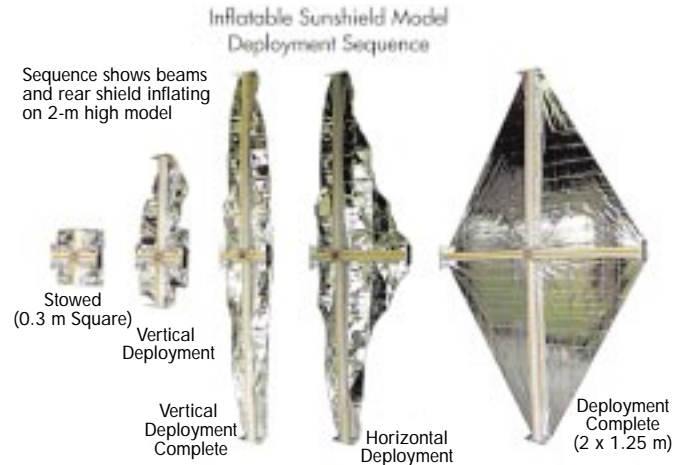

FIGURE 10.6. The deployment of a prototype ISIS shield. (NASA/GSFC)



FIGURE 10.7. A hexapod vibration-suppression stage using active and passive members. (NASA/JPL)

Operations Technology

The operations concept for NGST will be designed to ensure the health and safety of the observatory, minimize the cost of the flight and ground systems during all phases of the program and maximize the science return and access to NGST data. We

take these goals to imply a significant level of spacecraft autonomy, a highly streamlined approach to ground operations and a well-designed architecture of protocols and tools to aid the planner and the scientific user at all phases of an observation — proposal to archival research.

An explosion in information and communications technology, driven primarily by commercial applications, will prove useful to NGST. Reliable, high-volume network technology and advanced file management and file-transfer protocols developed for Internet users will greatly simplify NGST user interfaces in a Web-type environment. Efficient, lossless data compression algorithms and advanced communication

codes — now under development for high-volume data missions and applications — will enable highly efficient ground/space communications and data transfer.

The chief challenges for NGST operations are reducing development and operations costs, while ensuring reliable and responsive control of the spacecraft and the science mission. The key technology tall poles are objective-oriented mission planning, autonomous schedule execution by the flight computer, and autonomous fault management both on-board and on the ground. We will develop flight software methodologies that will allow operators to tell the spacecraft to perform a series of tasks in a planned sequence but not at specific times. If an anomaly occurs, NGST will correct the problem if possible. If necessary, the spacecraft will go into a safe configuration and alert ground operators to the condition. There will be no need for 24-hr coverage at the operations center. Smaller missions, such as FUSE, will incorporate many of these features. These steps must be taken in coordination with the other NGST system technologies (OTA, SI Module, SSM) and designs. We will develop an operations testbed, a hardware and software simulation of the NGST flight system, to test these technologies.

Systems Technology

The NGST will be a complex system involving multiple optical, electrical, structural, thermal, mechanical and control elements, many of which will operate in a highly integrated manner supporting multiple tasks. Every subsystem will have ambitious requirements contributing directly to the overall performance of the mission. The question arises then: which NGST architecture or mission will most effectively use existing and emerging technologies to provide the maximum science return? Also, how will we validate and qualify key technologies, and integrate and test NGST components, systems and subsystems to reduce the risk of failure?

In the past few years, industry and NASA have developed integrated computational modeling capabilities for complex systems. They can help us answer the questions posed above. For instance, the Integrated Modeling of Optical Systems (IMOS) tool developed at JPL can combine structural, thermal, control and disturbance models of a complex system and predict the overall performance in terms of simulated science data products. Figure 10.8 shows typical IMOS products, including a prediction of OTA thermal gradients and a corresponding image of a bright star in the SI Module focal plane after wavefront corrections. Using IMOS, we can build a model of NGST that shows the scientific

impact of design decisions. Such tools will enable mission designers to optimize the NGST architecture and will be part of the testing and actual operations of the observatory. *The modeling of testbeds and pathfinders and the comparison of predicted results to actual performance are the core of the NGST validation process for technological readiness.*

An important aspect of NGST systems technology is its evolutionary nature.

- Models of the type just described will be used to guide technology development.
- Existing technologies will be combined with key innovative developments and tested in incremental steps to build confidence in the underlying concepts, components, software and integrated systems.
- The technology programs will emphasize development of hardware and software products, not paper studies.
- Subsystem testbeds, such as those for wavefront sensing and control and for deployable structures, will be developed to prove the integrated performance of key sub-system elements.
- Flight demonstrations will be used where ground testing is not possible or practical.
- A system testbed and mission simulator will be developed — a virtual NGST — that will incorporate models, software and hardware representing all critical functions of the NGST, from science investigations and flight systems, to operations.

These capabilities and facilities will support mission architecture development, as well as integration, test and operation during later stages of the program.

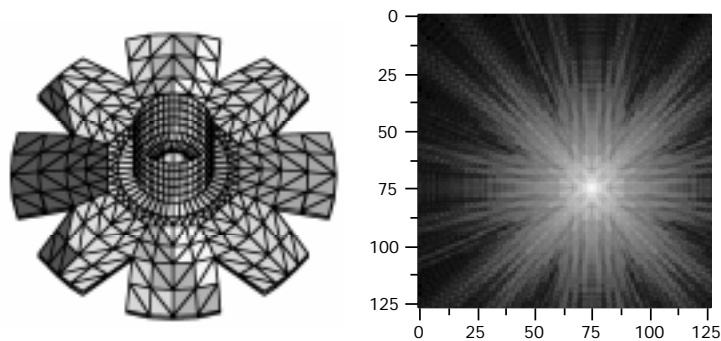

FIGURE 10.8. Left panel: IMOS finite element model predictions of thermal gradients on the OTA; right panel: Simulated point spread function at the SI Module science focal plane. (NASA/JPL)

Launch Shroud Technology

One of the critical choices the NGST architects will make is whether to proceed with a deployable primary mirror or use a smaller monolithic mirror that would require the development of a launch shroud to place it in orbit. Ironically, the smaller mirror and larger shroud would need a larger launch vehicle, one which might be made available by collaborating with an international partner. Placed in a low-background orbit, far from the Earth (~3 AU), a 6 m NGST provides scientific return comparable to that of a 8 m version closer to the Earth (L2 or drift-away orbit).

The largest launch shrouds currently available or under development can accommodate payloads with approximately 4.5 m diameters and 10 m in length on very large launch vehicles, such as the Proton, Ariane V or the H II (see Table 5.2). Launching an observatory equipped with a 6 m diameter monolithic aperture and a fixed sunshade would require a shroud of 7–8 m in diameter. We anticipate that competitive forces will drive the launch service industry to provide 5 m diameter shrouds for mid-sized launchers soon, but we do not expect 7–8 m shrouds to be commercially available by NGST's launch date. The DoD has considered studying shrouds as large as 8 m, but it is not currently pursuing it. We will undertake a feasibility study of developing a large shroud, possibly in conjunction with the DoD. The results of the study, combined with a thorough analysis of the impact on the science return, will be essential for selecting the best NGST mission concept. If a monolithic option appears attractive and feasible, we will initiate an advanced-shroud development and demonstration program on a time scale consistent with delivering a proven shroud for the NGST launch.

Technology Flight Demonstrations and Experiments

The strategy for validating NGST technology, using ground demonstrations, testbeds and simulators, was outlined in Section 10.5. Some advanced technologies may not be adequately or practically tested on the ground due to the nature of the terrestrial environment or lack of facilities. Examples could include characterization of an inflatable sunshade and understanding the nonlinear and low-amplitude dynamics of precision structural and optical components in the microgravity environment. Furthermore, demonstrating key elements in a small-scale integrated flight experiment would provide valuable experience and confidence in the full-scale mission.

While the benefits of space demonstrations and experiments are significant, the cost of even the simplest space mission is substantial. We must show a significant cost-benefit advantage to justify technology demonstrations in space. It is true that opportunities to fly small payloads at an affordable price are increasing. Potential carriers include the Shuttle, the Spartan spacecraft, Astro-Spas and the International Space Station. Other opportunities for shared flights with other launchers and missions also exist. We currently plan a series of three Pathfinder flight experiments. The first will be a Shuttle-launched free flyer to demonstrate an inflatable sunshield; the second will be a series of Shuttle-attached payloads to evaluate the effects of gravity release on a lightweight mirror and on precision deployment mechanisms; and the third, if required, will be a Shuttle-launched, free-flying deployable optics experiment. The NGST program will carefully evaluate the needs and opportunities for these and other flight demonstrations and experiments and will pursue those deemed essential to reduce risk to an acceptable level, possibly in collaboration with international partners or other government agencies.

Shared Technology within NASA

Technology for NGST will not be developed in a vacuum. Throughout this chapter we have described numerous technologies that will be acquired from other sources. Examples include infrared sensors and passive cooling technology from SIRTF, information technology from industry, advanced spacecraft components from commercial satellite builders and innovative space-qualified technology from the NASA New Millennium and MIDEX programs. We plan to take full advantage of technologies now being developed elsewhere within NASA and other government agencies, universities, national observatories and international collaborators. For example, ESA has agreed to review the NGST program for technologies it might share with the FIRST mission, and we will undertake a reciprocal study of FIRST and other international missions.

NGST is an element of NASA's Origins Program, which also includes SIM, TPF and, far in the future, the Terrestrial Planet Mapping Array. These missions share many overlapping technology needs. Consequently the necessary technology needed will be developed in a coordinated and concerted manner to maximize effectiveness. NGST will benefit from the vibration-suppression techniques and deployable-structures technologies developed for the SIM. It also will pass along technologies in the fields of cryogenic optics and advanced infrared

Table 10.1. Technologies Common to the Origins Missions

Technology	Space Interferometry Mission	NGST	Terrestrial Planet Finder
Cryogenic optics		√	√
Deployable structures	√	√	√
Inflatable structures		√	
Passive cooling		√	√
Vibration suppression	√	√	√
Nanometer metrology	√	√	√
Picometer metrology	√		√
Active optics	√	√	√
Precision pointing	√	√	√
Cryo coolers		√	√
IR focal planes		√	√
Visible focal planes	√	√	
On-board propulsion		√	√
Autonomous operations		√	√
Integrated modeling	√	√	√

focal planes to missions like the TPF. Table 10.1 shows some of technology commonality among the Origins missions.

NGST Technology-Development Process and Roadmap

The NGST technology development process is depicted graphically in Figure 10.9. We have completed the lefthand side of the diagram: a series of NGST feasibility studies leading to roadmaps and priority lists for developing critical technologies. A summary NGST technology-development roadmap is shown in Figure 10.10. A technology development program has been initiated in FY'97 addressing the tall tent poles. The emphasis is on hardware and software products, which are essential for reducing development costs. The program is guided by the progress and results of the NASA-led NGST architecture modeling activity and by industry system studies to be initiated in FY'97. Critical technology per-

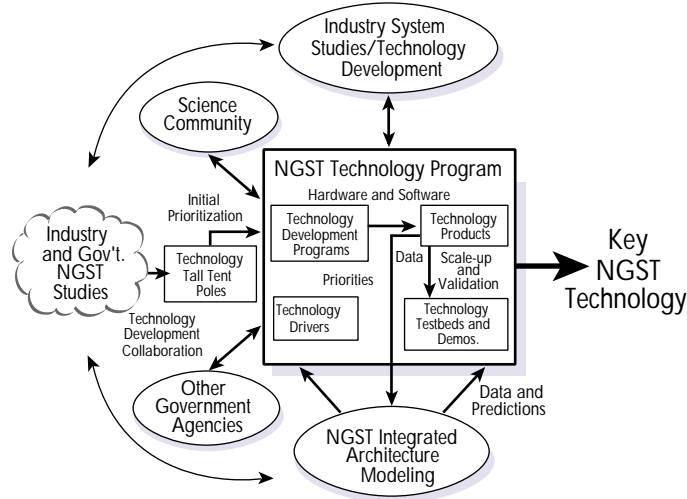

FIGURE 10.9. NGST Technology Development Process. The technology program is the central element in the early years of the NGST mission development. NASA is establishing the architecture modeling and industry study programs in FY'97. (NASA/JPL)

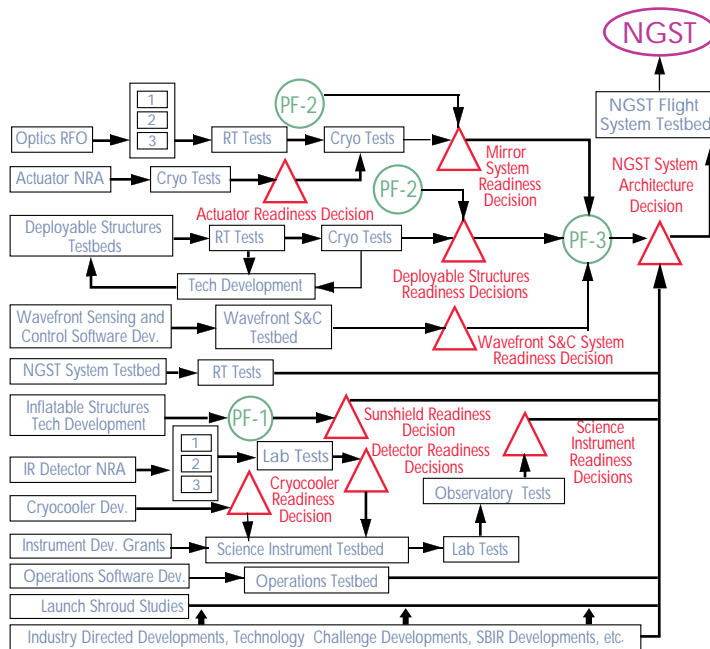

FIGURE 10.10. The NGST Technology Roadmap. (NASA/JPL)

formance goals and priorities have been established and will be reviewed as the mission architectures mature. The technology program will, in turn, provide performance data from real hardware for incorporation in mission and subsystem models. *We anticipate that the technologies, testbeds and simulators developed in this program will be developed primarily by those who will actually design, build and operate NGST.* This simplifies or eliminates the need for technology transfer and maximizes the technology's value to the mission. Regular interaction and collaboration with the science community, industry and other technology developers will be a key element of the program, as will regular progress workshops and reviews.

The Costs of Reaching Readiness

In this chapter, we have touched on some of the key technologies important to NGST, and outlined strategies, plans and a roadmap to acquire them. We believe that with adequate support, dedicated effort and early development, these technologies can be brought to bear to enable a highly capable, cost effective NGST mission. The estimated costs of the technology development effort is approximately \$113M over a 6-year period — not including costs associated with flight experiments, which could add \$60M or more depending on their number and complexity. Costs associated with the development of a new launch shroud are also not included in this estimate. The distribution of resources among the various technology areas is shown in Table 10.2.

TABLE 10.2. NGST Technology Development Budget Estimate*

Technology Area	Required Resources (\$M)
Component, assembly, and subsystem technology development	68.7
System testbeds and modeling tools	44.0
Flight experiments	61.5
Total	174.2

*These resources are required to implement the technology roadmap.

APPENDIX A

CONTRIBUTORS TO NGST STUDY

THIS REPORT summarizes the contributions of many people and organizations to the NGST Study. We are pleased to acknowledge their hard work, expertise and enthusiasm for the NGST mission.

The Scientific Oversight Committee

Roger Angel	<i>University of Arizona</i>
Len Cowie	<i>University of Hawaii</i>
Wendy Freedman	<i>Carnegie Observatories</i>
Jim Houck	<i>Cornell University</i>
Robert Kennicutt (Chair)	<i>University of Arizona</i>
Robert Kirshner	<i>Harvard University</i>
Gillian Knapp	<i>Princeton University</i>
Jerry Nelson	<i>Lick Observatory</i>
Mike Werner	<i>California Institute of Technology</i>
Edward Wright	<i>UCLA</i>
Harley Thronson	<i>University of Wyoming</i>
John Mather	<i>NASA/GSFC</i>
Peter Stockman	<i>Space Telescope Science Institute</i>
Alvio Renzini	<i>European Southern Observatory</i>
Piero Benvenuti	<i>ST-ECF</i>

The Combined Science Working Group for the Three Studies

Tom Ake	<i>Computer Sciences Corp.</i>
Rudi Albrecht	<i>ST-ECF/ESO</i>
France Allard	<i>Wichita State University</i>
Roger Angel ¹	<i>University of Arizona</i>
Stefi Baum	<i>Space Telescope Science Institute</i>
Piero Benvenuti	<i>ST-ECF/ESO</i>
Luciana Bianchi	<i>Space Telescope Science Institute</i>
Ralph Bohlin	<i>Space Telescope Science Institute</i>
Veronique Buat	<i>CNRS, Marseille</i>
Denis Burgarella	<i>CNRS, Marseille</i>
Richard Burg	<i>Johns Hopkins University</i>
Chris Burrows ¹	<i>ESA/STScI</i>
Rich Capps	<i>Jet Propulsion Laboratory</i>
Ken Carpenter	<i>Goddard Space Flight Center</i>
Peter C. Chen	<i>Goddard Space Flight Center</i>
Edward Cheng	<i>Goddard Space Flight Center</i>

Mark Clampin	<i>Space Telescope Science Institute</i>
Stefano Casertano	<i>Space Telescope Science Institute</i>
Roc Cutri ¹	<i>IPAC/Caltech</i>
Magali Deleuil	<i>CNRS, Marseille</i>
Mark Dickinson	<i>Space Telescope Science Institute</i>
Megan Donahue	<i>Space Telescope Science Institute</i>
Rodger Doxsey	<i>Space Telescope Science Institute</i>
Michael Fall	<i>Space Telescope Science Institute</i>
Harry Ferguson	<i>Space Telescope Science Institute</i>
William Forrest	<i>University of Rochester</i>
Robert Fosbury	<i>ST-ECF/ESO</i>
Ted Gull	<i>Goddard Space Flight Center</i>
Jim Gunn ¹	<i>Princeton University</i>
Richard Griffiths	<i>Carnegie Mellon</i>
Robert Hanisch	<i>Space Telescope Science Institute</i>
Zoltan Haimon	<i>CFA, Harvard</i>
Hashima Hasan	<i>Goddard Space Flight Center -HQ</i>
Timothy Hawarden	<i>JAC, Hawaii</i>
James Houck	<i>Cornell University</i>
Myungshin Im	<i>Space Telescope Science Institute</i>
Yoji Kondo	<i>Goddard Space Flight Center</i>
Anuradha Koratkar	<i>Space Telescope Science Institute</i>
Richard Kurz	<i>Gemini Project</i>
David S. Leckrone	<i>Goddard Space Flight Center</i>
Chuck Lillie ²	<i>TRW</i>
Avi Loeb	<i>CFA, Harvard</i>
John MacKenty	<i>Space Telescope Science Institute</i>
Peiro Madau	<i>Space Telescope Science Institute</i>
Michael Margulis ¹	<i>Lockheed Martin</i>
Buddy Martin	<i>University of Arizona</i>
John Mather (CoChair)	<i>Goddard Space Flight Center</i>
Craig McCreight	<i>Ames</i>
Charley McNoecker	<i>Ball Brothers</i>
Matt Mountain	<i>Gemini Project</i>
Harvey Moseley ²	<i>Goddard Space Flight Center</i>
Malcolm Niedner	<i>Goddard Space Flight Center</i>
Keith Noll	<i>Space Telescope Science Institute</i>
Colin Norman	<i>Space Telescope Science Institute</i>
Saul Perlmutter	<i>University of California, Berkeley</i>
Brad Peterson	<i>Ohio State University</i>
Larry Petro	<i>Space Telescope Science Institute</i>
Judy Pipher	<i>University of Rochester</i>
Marc Postman ²	<i>Space Telescope Science Institute</i>
David C. Redding	<i>Jet Propulsion Laboratory</i>
R. Michael Rich	<i>Columbia University</i>

¹Participated in Lockheed Martin Study.

²Participated in TRW Study.

Richard Robinson	<i>Goddard Space Flight Center</i>
Michael Rosa	<i>ST-ECF/ESO</i>
Abhi Saha	<i>Space Telescope Science Institute</i>
Chris Skinner	<i>ESA/STScI</i>
Eric Smith	<i>Goddard Space Flight Center</i>
Massimo Stiavelli	<i>ESA/STScI</i>
Peter Stockman (Co-Chair)	<i>Space Telescope Science Institute</i>
Rodger Thompson	<i>University of Arizona</i>
Harley Thronson	<i>NASA/HQ</i>
Virginia Trimble	<i>University of Maryland</i>
Meg Urry	<i>Space Telescope Science Institute</i>
Mark Voit	<i>Space Telescope Science Institute</i>
Lawrence A. Wade	<i>Jet Propulsion Laboratory</i>
Jim Westphal ¹	<i>California Institute of Technology</i>
Rick White	<i>Space Telescope Science Institute</i>
Ned Wright ²	<i>University of California, LA</i>

Institutional and Corporate Participation

Allied Signal Aerospace	NASA Ames
ATSC	NASA Goddard Space Flight Center
Ball Aerospace	NASA Marshall Space Flight Center
Columbia University	Naval Research Laboratory
Composite Optics, Inc.	New Focus Inc.
Eastman Kodak Co.	NSWC
European Southern Observatory	Omitron
Garman Systems Inc.	Optical Research Associates
Harris Corp.	Santa Barbara Research Center
Hughes Danbury Optical Systems	SoI Visions
Highes-STX	Space Telescope European Coordinating Facility
Jackson & Tull	Space Telescope Science Institute
Jet Propulsion Laboratory	SSG
Johns Hopkins University	Swales & Associates
Joint Astronomy Centre	ThermoTrex Corp.
Kodak Corp.	University of Alabama
L'Garde Inc.	University of Arizona
Langley Research Center	University of Colorado
Left Hand Design	University of Rochester
Lockheed Martin-East	US Air Force Philips Laboratory
Massachusetts Institute of Technology	Westwind Co.

The Three Study Teams

TRW's NGST Study Team

TRW Corp.

Chuck Lillie (Study Lead)	Tom Fitzgerald	Paul Nachman
Frank Balmano	Bob Gough	Henry Pan
Klaus Biber	Gary Grimm	Shirley Savarino
Allen Bronowicki	Bob Greenberg	Chris Shelton
Fred Cottrell	Chuck Greenwald	Dick Sherwood
Don Davies	Charles Hackett	Nelson Wallace
Ray DeLong	David Huang	Wendy Watson
Boris Dobrotin	Keith Kroening	Michael Wehner
Martin Flannery	Greg Lee	Dave Werts
	Bruce Marcus	Tim York

HDOS Team

George Bossers	Mike Krim	Malcolm MacFarland
----------------	-----------	--------------------

GSFC Team

Philip Chen	John Martin	Oren Sheinman
Jim Cooley	Harvey Moseley	Eric Young
John Deily	Wes Ousley	John Vranish
Judy Gibbon		

Swales Team

Stan Sobieski	Ed Devine	Ed Meyer
Sahag Dardarian	Bob Eby	Jack Triolo

LaRC Team

Elvin Ahl	Steve Sandford	Anne StClair
Ruth Amundsen	Joycelyn Simpson	Jessica Woods-
Keith Belvin	Diane Stoakley	Vedeler
Garnet Horner		

Westwind Team

Ed Wood

Cornell Team

Jim Houck

UCLA Team

Ned Wright

STScI Team

Marc Postman

NSWC Team

Joe Teter

*Lockheed Martin's NGST Study Team***Lockheed Martin Missiles and Space**

Dominic Tenerelli (Study Lead)	Bill Rosenberg	Lou Deaton
Alan Duncan	Jim Lempke	Gerhard Franz
Lori Clampitt	Larry Mendoza	Tom Sherrill
Mike Margulis	Sharod Broadhead	Dave Schaecter
Frank Adams	Dennis Haas	Ray Falmoe
Andy Klavins	Maurice Corlandi	Don Davis
	Kin Chan	Amy Mainzer

University of Arizona

Roger Angel	Steve Miller	John Kapp
Dean Ketelson	Ann Bauer	Richard Kraff
Buddy Martin	Lee Dettman	Bryan Smith

ThermoTrex Corp.

Dave Sandler	Don Bruns
Kevin Kell	Brad Lappin

Composite Optics Inc.

Shel Kulick

Eastman Kodak Co.

Tom Casey	Ted Miller	Peter Jones
Suzanne Horbatuck	Greg Hull-Allen	Mike Johnston
Dennis Thompson		

Harris Corp.

Ron Briley	Frank Bourne	Johnny Batache
------------	--------------	----------------

Massachusetts Institute of Technology

David Miller
Homero Gutierrez

Allied Signal Aerospace

Art Bradley

New Focus Inc.

Mark Enright

*Goddard Space Flight Center's NGST Study Team***NGST Systems Group**

Bernie Seery (Study Lead)	Delores Faison	Debora Miller
Bob Beaman	Melanie Feinstein	John D. Mather
Pierre Bely	Gloria Goodman	Ralph Mollerick
Lisa Carroll	John Humphreys	Gary Mosier
Dan Coulter	Mark Kahan	Lloyd Purves
Tony Cruz	Mark Jarosz	Chuck Perrygo
Mark Daigle	Kevin M. Jones	Charles N. Phelps
Danny Dalton	Keith Kalinowski	Peter Stockman
	Gary Martin	Marty Yoo

NGST Optic IPT

John Humphreys (Lead)	Mike Krim	David Redding
Jim Bilbro	Shel Kulick	John Redmon
Roger Angel	Mark Lake	Bill Roybal
Pierre Bely	Henry Lee	Greg Schunk
Richard Carreras	Felix Lopez	Bob Shannon
Dan Coulter	Paul Luz	Martin Smithers
Larry Craig	Landis Markley	Len Solomon
Charles Darby	John Mather	John Spina
Marc Daigle	Martin Mikulas	Gary Thornton
Mark Gerry	Dave Miller	Jeff Umland
James Hadaway	Sandy Montgomery	John Vranish
Howard Hall	Max Nein	Henry Waites
David Jacobson	Roland Plante	Mark West
William Jones	Andy Prince	Bill Wetherell
Mark Kahan	John Rakuczy	Dick Wollensac

NGST SI Module IPT

Pierre Bely (Lead)	Bill Forrest	John MacKenty
Rudy Albrecht	Robert Fosbury	Piero Madau
Stefi Baum	Ed Freymiller	John Mather
Piero Benvenuti	Larry Germann	Peter Maymon
Ralph Bohlin	Ted Gull	Craig McCreight
Richard Burg	Tim Hawarden	Wally Meyer
Chris Burrows	Allan Hoffman	Guy Monnet
Stefano Casertano	Keith Kalinowski	Harvey Moseley
Steven Castles	Peter Kittle	Judy Pipher
Ed Cheng	Anuradha Koratkar	David Redding
Mark Clampin	Dale Lawrence	Mike Rich
James Crocker	Duccio Macchetto	Michael Rosa
Tom Dixon	Steven Macenka	Bernie Seery
Jacky Fischer		

NGST SI Module IPT (continued)

Chris Skinner	Donald Strecker	Jeremy Walsh
Massimo Stiavelli	Rodger Thompson	Mark Wilson
Peter Stockman	Larry Wade	Robert Woodruff

NGST Spacecraft IPT

Bernie Seery (Lead)	Randy Hedgeland	Lloyd Purves
Dennis Asato	Keith Kalinowski	Mike Rhee
Pierre Bely	James Kelley	George Roach
Scott Benson	Frank Kirchman	Timothy Sauerwein
John Celmer	Mike Lee	Joe Schepis
Michael Choi	Philip Luers	Becky Short
Cherie Congedo	Landis Markley	Hsiao Smith
Lamont DiBiasi	Gary Martin	Tom Styczynski
Mike DiPirro	Mike Mesarch	John Vranish
Michael Femiano	Ralph Mollerick	Evan Webb
Lou Hallock	Gary Mosier	Mark Wilson
William Hayden	Yi Ngan	Eve Wooldridge

NGST Operations IPT

Keith Kalinowski (Lead)	Ted Gull	Bill Oegerle
Tom Ake	Lou Hallock	Larry Petro
Dan Berry	Kit Harvel	Dale Shama
John Carraway	Eric Issac	Elaine Shell
Bill Crabb	Lou Kalil	Peg Stanley
Andy Dougherty	Jack Leibee	Steve Tompkins
Les Deutsch	Bruce Love	Peter Vedder
Rodger Doxsey	Glenn Miller	Ron Vento
Larry Dunham	Dave McComas	Chris Wilkinson
	Rich Miller	

APPENDIX B

REFERENCES AND SUGGESTED READING

Reports

A Road Map for the Exploration of Neighboring Planetary Systems (ExNPS), The ExNPS Team, ed. C. A. Beichman, JPL Publ. 96-22, 1996.

A Scientific Assessment of the New Technology Orbital Telescope, Task Group on BMDO New Technology Orbital Observatory, National Academy Press, 1995.

Astrotech 21 Space Infrastructure Handbook, ed. J. Fordyce, JPL D-7430, 1990.

Exploration and the Search for Origins: A Vision for Ultraviolet-Optical-Infrared Space Astronomy, Report of the HST & Beyond Committee, ed. A. Dressler, AURA, 1996.

EDISON, an M3 Proposal to ESA, ed. H.A. Thronson (Didcot: Rutherford Appleton Labs), 1993.

High-Z: A Near-IR Space Telescope for Probing the Early Universe, a proposal to New Mission Concepts for Astrophysics, STScI, 1994.

Hubble Space Telescope Wide Field and Planetary Camera 2 Instrument Handbook, ed. C.J. Burrows, STScI, Version 3.0, 1995.

Kilometric Space Interferometry, Comparison of free-flyer and moon-based versions, Report of the Space Interferometry Study Team, ESA, 1996.

Lockheed Martin NGST Final Study Report, LMMS/PO86946, August 1996.

Report of the HST Strategy Panel: A Strategy for Recovery, ed. R.A. Brown and H.C. Ford, STScI, 1991.

Science Instrument Module for NGST, an interim report by the Integrated Product Team for the GSFC NGST, STScI, 1996.

The Decade of Discovery in Astronomy and Astrophysics, Astronomy and Astrophysics Survey Committee, National Academy Press, 1991.

The Edison Scientific Programme, The Edison Working Group, 1994.

The Future of Space Imaging, Report of a Community-based Study of an Advanced Camera for the Hubble Space Telescope, ed. R.A. Brown, STScI, 1993.

The Next Generation Space Telescope, ed. P.-Y. Bely, C.J. Burrows, and G.D. Illingworth, STScI, 1989.

TRW NGST Final Study Report, TRW, 1996.

Working Papers, Astronomy and Astrophysics Panel Reports, Astronomy and Astrophysics Survey Committee, National Academy Press, 1991.

Papers

Angel J.R.P., Martin B., Miller S., Hinz P., Woolf N., Sandler D., Bruns D., and Tenerelli D., *NGST as a Fully Assembled 6 m Telescope, Using a Monolithic MARS Mirror*, a white paper to NASA, Univ. of Arizona, 1997.

Colley W.N., Rhoads J.E., Ostriker J.P., and Spergel D.E. *Are Hubble Deep Field Galaxy Counts Whole Numbers?* *Astrophysical Journal*, **473**:L63, 1996.

Charlot S., Worthey G., and Bressan A. *Uncertainties in the Modeling of Old Stellar Populations*. *Astrophysical Journal*, **457**:625, 1996.

Ferguson H.C., Williams R.E., and Cowie L.L. *Probing the Faintest Galaxies*. *Physics Today*, **50**:4, 24, 1997.

Haiman Z. and Loeb A., *Signatures of Stellar Reionization of the Universe*. *Astrophysical Journal*, in press, 1997.

Haiman Z., Rees M.J., and Loeb A., *H₂ Cooling of Primordial Gas Triggered by UV Radiation*, *Z. Astrophysical Journal*, **467**:522, 1996.

Haiman Z., Rees M.J., and Loeb A. *Destruction of Molecular Hydrogen During Cosmological Reionization*. *Astrophysical Journal*, **476**:458, 1997.

Hawarden T.G., Cummings R.O., Tesco C.M., and Thronson H.A., *Optimised Radiative Cooling of Infrared Space Telescopes and Applications to Possible Missions*. *Space Science Reviews*, **61**:113, 1992.

Kirshner R.P. et al. *SN 1992A: Ultraviolet and Optical Studies Based on HST, IUE, and CTIO Observations*. *Astrophysical Journal*, **415**:589, 1993.

Leitherer C. and Heckman T. *Synthetic Properties of Starburst Galaxies*. *Astrophysical Journal Supplement*, **96**:9, 1995.

Madau P., Ferguson H.C., Dickinson M.E., Giavalisco M., Steidel C.C., and Fruchter A.S., *High Redshift Galaxies in the Hubble Deep Field. Color Selection and Star Formation History to z~4*, *Monthly Notices of the Royal Astronomical Society*, **283**:1388, 1996.

Miralda-Escude J. and Rees M.J. *High Redshift Supernovae and the Metal-Poor Halo Stars: Signatures of the First Generation of Galaxies*. *Astrophysical Journal*, **478**:L57, 1997.

Moorwood A.F.M. et al. *2.5–45 mm Spectroscopy of the Circinus Galaxy*. *Astronomy and Astrophysics*, **315**:L109, 1996.

- Mountain M. *What Is Beyond the Current Generation of Groundbased 8 m -10 m Class Telescopes and the VLT-I?* Gemini Preprint No. 11, 1996.
- Perlmutter S. et al. *Scheduled Discoveries of 7+ High-Redshift Supernovae: First Cosmology Results and Bounds on q_0* . Astrophysical Journal, in press (WWW astro-ph/9608192), 1997.
- Ostriker J.P. and Gnedin N.Y. *Reheating of the Universe and Population III*. Astrophysical Journal, **472**:L63.
- Stiavelli M., Stockman H., and Burg R. *The Next Generation Space Telescope Design Reference Mission*. ST-ECF Newsletter, **24**:4, 1997.
- Thronson H.A., Rapp D., Bailey B, and Hawarden T.G., *Ecological Niches in Infrared and Submillimeter Space Astronomy as a Function of Observatory Parameters*. PASP, **107**:1099, 1995.
- Wade L.A., Lilienthal G.W., Tereby S., Kadogawa H., Hawarden T.G., Rourke K, and Van Buren D., *Mid-Infrared Optimized Resolution Spacecraft (MIRORS)*. JPL, 1995.

APPENDIX C

THE DESIGN REFERENCE MISSION

ALTHOUGH A LARGER AND MORE CAPABLE TELESCOPE will always be preferable to a lesser one, we must strike a balance between scientific capabilities and technical (and financial) feasibility. In certain technical areas, we may gain significant scientific return for relatively modest cost. In other areas, the price is more dear. Since NGST must accomplish a number of scientific goals with different needs, striking the correct balance is not straightforward. To help us, the NGST Science Working Group established a "strawman" observing program based on key scientific questions identified in the HST and Beyond Committee report as well as astronomical research requiring NGST capabilities. The program is a shopping list of the highest-priority observations and a price list of the times that the observations require. We use the simple sensitivity equation described in Chapter 2 to create the price list. These include all the major attributes of the observatory: size, instruments, optics temperatures and celestial foreground. By comparing the time required for each observation and the total time required, we can see how each parameter changes the mission outcome. Because of its importance in the actual design of the mission, the science program is called the Design Reference Mission (DRM). The composition of the science program is shown in Table C.1. We caution that Table C.1 represents the first of many iterations between scientists and engineers and should not be taken literally. However, if we have established approximately the correct balance among the research themes, we expect that the sensitivity analysis will be correct. We provide brief descriptions of the overall science program and each of the core research goals and important instrumental capabilities in the table.

Scientific Goals for the NGST Science Mission

About 70% of the NGST science mission is a core program, designed to address the origins of galaxies questions outlined in Chapter 1 and the goals established by the HST and Beyond Committee report. It represents the minimum that NGST should achieve. We add a broad range of other programs within the NASA Origins theme (star formation and the formation and evolution of planetary systems) as well as many others that NGST would make possible. Although the selection of the scientific elements is subjective and strongly reflects current scientific interests, we believe it represents the best science NGST can do.

Table C.1. The NGST Science Mission

Programs (Core and Supplemental)	Modes	Flux Level (nJy)	No. of Obs	Total Time (days)	Mission Fraction for 6 m	Mission Fraction for 8 m
Early formation of stars and galaxies	NIR NIRS	0.4–270	393	204	11%	11%
Structure and dynamics of galaxies at $z > 2$	NIR NIRS MIR MIRS	0.4–4 4–280 80–350 1000	3347	554	31%	16%
Distant supernovae	NIR NIRS	1.4 2.8	817	485	27%	9.3%
Nature's telescope	NIR	70	179	20	1%	0.6%
Stellar populations in nearby universe	NIR MIR	0.6–2.3 600–5000	517	355	19%	7%
Solar system	NIR MIR	3–1000 140–1000	1648	99	5%	2%
Protostellar Systems & Studies of the IMF in Star forming regions	NIR NIRS MIR MIRS	2–10000 70–10000 100–1000 >1000	2400	20	1%	0.6%
Individual object classes	NIRS MIR	70–1000 66–16000	668	222	12%	5%

The Early Formation of Stars and Galaxies (CORE)

We will obtain a series of deep field images in four to five visible and NIR color bands to identify the population of galaxies and star-forming regions in the distant and early universe. Because we are unsure whether the universe is flat or open, we have adopted a strategy to cover each possibility and to provide sufficient bright, high-redshift sources for spectroscopic confirmation. To study an open universe, we will image a few narrow fields to great depth (~ 0.3 nJy). The early objects will be fainter, but should be more numerous. To study the flat universe, we will image 100 flanking fields (0.5 square degrees) to a more shallow depth (~ 3 nJy). In this cosmology, distant galaxies should appear brighter, but be less numerous. In each field, we will

select objects for low-resolution spectroscopic studies to confirm their redshift and classification ($R = \lambda/\Delta\lambda = 100$). In a flat cosmology, we expect to discover over 10^4 high redshift galaxies ($z > 5$) in each deep field. We will be able to confirm the redshift of only a small fraction of these (~ 10 – 100) by spectroscopy in each field.

The HDF has shown that faint galaxies appear small, about $0.1''$ in radius. Colley et al. (1996) show that imaging worse than HST's results in loss of sensitivity and undercounting the number of galaxies. Using the models of Haimon and Loeb (1997), we find that we need almost one square degree of field to find 100 bright (>10 nJy) sources at high redshift ($z > 14$), near the epoch of reionization. Wide field imaging and multi-object spectroscopy are essential for the accomplishment of this core program.

The Structure and Dynamics of Galaxies at $Z > 2$ (CORE)

High-redshift galaxies and star-forming regions discovered in the Hubble Deep Field and the NGST shallow surveys will often display complex structures due to merging, galaxy-galaxy interactions, spiral-wave star formation and chance superposition. We will obtain moderate-resolution, imaging spectroscopy of these structures and those of nearby galaxies to study the dynamics of these systems. We can confirm that different elements are bound by gravity if their velocities are identical. Moreover, we can study the mass within each galaxy (mass that may be dark) by measuring the temperature or collective motions of the stars and gas clouds within the galaxy. We chose about 100 targets, including primeval bright spheroids, distant disk structures and galaxy- and star-forming regions near distant AGN.

This program requires resolutions of $\lambda/\Delta\lambda = 1000$ – 4000 to study the dynamics of distant, established galaxies at $z = 3$ and nearer, low-mass galaxies forming at the peak of star formation, $z = 1$ – 2 . The angular resolution must be sufficient to resolve galaxies into individual components, again $0.05''$ – $0.1''$. The feasibility of MIR spectroscopic measurements will depend on the detector dark currents. We are optimistic that low dark current performance will be achieved and that 100 – 1000 nJy observations will be possible with resolutions of $\lambda/\Delta\lambda = 1000$.

Distant Supernovae (SNE) (CORE)

We will use the Type Ia and Type II SNe as standard candles to improve our knowledge of the universe's geometry and to measure the rate of massive star formation early in the formation of galaxies. Our goals are to discover ~ 100 SNe at redshifts greater than two and to follow them through the rise to maximum light and decline (about one

month in their rest frame and up to several years in ours). The study requires a repeated survey of a square degree of sky as well as sensitive, low-resolution spectroscopy to confirm preliminary redshift estimates based upon color and rise-time. The SNe field may overlap or complement the shallow flanking fields used for studying the early universe. High angular resolution is important to isolate Type II supernovae within their star-forming regions. Wide field imaging is crucial for this program because of the rare nature of these sources (about one per NGST field per year).

Nature's Telescope (CORE) and Dark Matter

Deep HST images and the NGST SNe fields and shallow surveys will discover excellent examples of gravitational lensing by clusters of galaxies. These chance alignments—approximately 0.1% of all sightlines—provide excellent opportunities to see distant galactic structures at high magnification, as well as superb opportunities to study the total mass distribution within the cluster. NGST's NIR sensitivity, wide-field imaging and HST-like resolution can reveal hundreds of distorted background galaxies at moderate redshift, $z = 1-3$, as well as the magnified images of star-forming regions at $z = 10-30$. We will study the evolution of cluster potentials and serendipitous ultra-distant galaxies using deep imaging and follow-up spectroscopy of approximately 20 gravitational lenses at redshifts between $z = 0.3-2.0$.

The NGST SNe and flanking fields will also reveal the growth of structure at redshifts not accessible to ground-based telescopes or SIRTF. At redshifts of $z = 5-10$ and for $\Omega_0 = 0.3$ (a popular cosmology), the angular size of a co-moving volume corresponding to today's 50 Mpc voids is approximately 0.25° . The 1° scale of the flanking fields is ideal for studying the correlations of distant galaxies and the growth of structure.

Stellar Populations in the Nearby Universe

Our understanding of the fossil stellar record only extends to our own galaxy and a handful of satellite galaxies. Using NGST's light-gathering power and HST-like resolution, we will analyze the stellar populations within the local group of galaxies and the Virgo Cluster of galaxies. Accurate, wide field imaging of single stars in 30 galaxies can provide the star-formation fossil record for the disks and outer portions of the inner bulge components of galaxies.

Imaging sensitivity at wavelengths as short as $\lambda = 0.5 \mu\text{m}$ is desired. High angular resolution is most important for these studies to reduce the effects of crowding. Ideally, NGST would have diffraction-limited, wide field imaging performance in the visible bands.

Kuiper Belt Objects and Protoplanetary Disks (The Origins of Planets)

The outer portion of our solar system contains millions of asteroids, with the largest almost 1000 km in diameter (approaching the size of our Moon). Most lie outside the orbit of Neptune and are probably remnants of our solar system's formation. Before the NGST launch in 2007, astronomers will have discovered about 100 of the brightest and nearest asteroids in the Kuiper Belt using HST and large ground telescopes. These objects and their distribution are not likely to be pristine, since they lie within or near the orbit of Neptune. We will obtain optical and NIR images in a wide-field Ecliptic Survey (1–2 square degrees at 3 nJy). Our goal is to discover an equivalent number of Kuiper Belt objects at greater radii from the Sun (>40 AU) and over a wide range of sizes. Mid-infrared signatures, such as silicate features, will be important in linking these objects, our closest proto-planetoids, to the great dust disks seen around early systems in Orion and β -Pictoris stars.

Protostars and the Initial Mass Function (IMF) of Star Forming Regions (The Origins of Stars)

At the April 1997 symposium on science with NGST, Steven Beckwith presented a program to measure the IMF for low mass stars and planet-sized objects in nearby star-forming regions. This program would be followed with spectroscopy of candidate objects and more detailed study of rare Class 1 and 2 protostars. Complete NIR surveys of the Orion, Pleiades, and Hyades star clusters would reveal >1000 brown dwarfs, and 50–1000 objects between 1 and 10 Jupiter masses, depending on the actual IMF. These surveys require wide field NIR imaging and high resolution ($\sim 0.1''$) to establish proper motions and cluster membership. Jupiter-mass objects would display a strong $10\ \mu\text{m}$ flux and spectral characteristics similar to the large gas planets in our own Solar System.

The MIR is essential for imaging the rare but important early phases of protostars. About 200 Class 1 protostars would be detected and resolved in the Orion nebula. These objects are inaccessible in the visible and near-infrared with visual extinctions $A_v \sim 100$. NGST images would complement the imaging of molecular emission by the next generation of millimeter wave interferometers. The sensitivity of NGST could be used to study bright protostars in star forming regions in the LMC, with spectral resolution $\lambda/\Delta\lambda > 1000$, and to detect T Tauri disks in M31.

Individual Object Classes

The capabilities of NGST will enable astronomers to undertake a rich variety of imaging and spectroscopic research. These include spectroscopy and imaging of the hidden universe (e.g., enshrouded star formation and AGN), regions of recent star formation and protoplanetary

nebulae in our own galaxy. Thousands of faint objects will be found by NGST deep surveys, such as very cool, low-mass white dwarfs and brown dwarfs. Other facilities, such as AXAF will find similar numbers of X-ray-selected, proto-AGN. These will be too faint for detailed NIR and MIR spectroscopy without NGST. The telescope's access to the continuous IR spectrum will permit planetary astronomers to analyze the surface compositions of asteroids, comets and planets. If high resolution MIR spectroscopy is provided by an etalon in the MIR spectrograph, it will be possible to detect the signatures of planet-sized gaps in the disks around young stars. The DRM contains a modest number of these programs, a number that we expect will grow. The extended MIR spectral range is important for these rare targets, as well as moderate resolution NIR spectroscopy, $\lambda/\Delta\lambda = 1000$.

Parametric Analysis

Using the Design Reference Mission, we have studied what NGST would accomplish if we change the size of the telescope diameter, the field of view of the cameras and spectrographs, and the quality of the detectors. The results are displayed in four panels of Figure C.1. Each panel indicates the fractions of the NGST core and extended science programs that would be accomplished in a five year mission for a range of these parameters. The GSFC 8 m diameter telescope (equivalent to a filled 7.2 m diameter telescope), 4 arcminute wide field of view (FOV), 50 K mirror temperature, and low noise detectors were used to develop the initial scope of the DRM. In this optimistic case, the core and extended program can be accomplished in about two years. General observers would subscribe the remainder of the five year mission for more specialized and focused science programs. If the diameter of NGST were smaller than 5 m, the core program could not be accomplished within 5 years. As Figure C.1 indicates, we can best compensate for moderate reductions in the telescope diameter by increasing the field of view of the cameras and imaging spectrographs. The time spent in surveys decreases sharply with increased field of view. Lowering the detector noise and telescope temperature makes more modest improvement in the mission outcome.

Several conclusions can be drawn from the parametric analysis:

- The minimum aperture required to accomplish the entire DRM within five years is $D > 6$ m. A 4 m aperture would accomplish only 20% of the DRM in five years.
- The minimum field of view is $FOV > 4' \times 4'$ for a 6 m NGST. A $3' \times 3'$ FOV, comparable to the FOV of the HST Advanced Camera for

Surveys, would accomplish the mission in 8 years. The length of the mission is almost inversely proportional to the size of the FOV.

- The NIR wavelength region plays a key role in all the DRM programs. The MIR ($\lambda > 5 \mu\text{m}$) is an important part of over 70% of the DRM programs and is critical in several Origins studies.
- The mirror temperature should be $T_{\text{mirror}} < 70 \text{ K}$. Higher temperatures, $T_{\text{mirror}} > 80 \text{ K}$, severely compromise the completion of the DRM even for telescopes with 7.2 m apertures such as the GSFC concept.
- Although high angular resolution was not an explicit parameter in these studies, we can estimate the minimum effect by noting that doubling the size of an unresolved image at $\lambda \sim 2 \mu\text{m}$ effectively halves the sensitivity of most observations. The impact is roughly equivalent to the difference between a 6 m telescope and a 7.2 m telescope. Thus, we can clearly see that *resolution at $\lambda = 2 \mu\text{m}$ comparable to that of HST at visible wavelengths is a key science driver.*

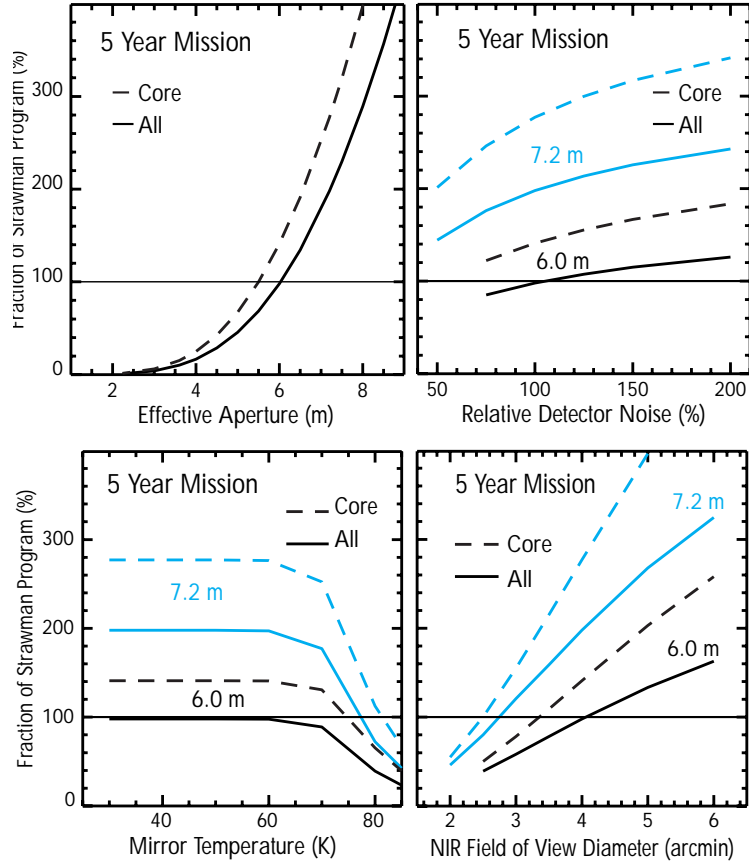

FIGURE C.1. Completed fraction of the NGST Design Reference Mission as a function of key design parameters. Dashed curves represent the core program; and solid curves represent the complete program (about 30% larger). The upper left panel illustrates the rapid increase in program completion with effective telescope diameter. The other panels show the effects of increasing field of view, decreasing detector noise, and increasing telescope temperatures. The detector noise includes dark current and read-out noise and is given relative to the values in the GSFC design. (Stiavelli/STScI)

APPENDIX D

THE NGST- δ CONCEPT

THE NGST- δ CONCEPT is a smaller, lower cost approach to NGST. In particular, the GSFC study team scaled the satellite to be compatible with a smaller vehicle. Thus the δ (delta) in NGST- δ signifies both a smaller NGST and one that is compatible with a Delta-class launch vehicle. Accomplishing this reduction in size meant reducing the scientific capabilities to only the core science mission. The aperture was reduced — a significant loss in sensitivity — and the extended wavelength coverage beyond 1–5 μm was eliminated.

The NGST- δ is inserted into a solar drift-away orbit by a three-stage Delta II 7925-H launcher with a stretched 3 m diameter payload fairing. The fairing is under development for the Earth Observing System PM mission. The H model of the Delta II is a version that uses the large strap-on solid rocket motors of the Delta III. With this launcher, we must reduce the 8 m payload mass by 48% and the stowed volume by 64%. In the future, the EELV-light launchers will have similar lift and payload volume capabilities.

Simply scaling the GSFC 8 m concept will not work. The aperture is too small and the volume reduction is impractical. Two new designs are shown in Figure D.1. Both have separate OTA, SI Module, and SSM assemblies for ease of design and development. The multi-cross mirror concept is axisymmetric from its primary mirror through the SI Module and SSM. The rectangular mirror concept is bi-symmetric with an offset SI Module layout. To accommodate the fairing volume, the study team designed the primary mirrors for both concepts to be segmented and folded. The primary mirror shapes on both configurations provide access for a secondary mirror deployed on a single arm. The arm consists of nested extension beam elements that stow behind the primary mirror and alongside the SI Module.

The optical system for both concepts consists of a three-mirror OTA and four Offner relays in the SI Module for a well corrected and wide field of view. Each of the four NIR subcameras incorporates a 4k x 4k InSb array. One subcamera includes an objective, grating-prism spectrograph. The focal plane plate scale is revised to provide a 6' x 6' field of view for the four subcameras. This larger field of view partially offsets the loss in sensitivity in the core science imaging surveys (see Appendix C). Use of the science detectors for star tracking remains feasible as the larger field of view compensates for the reduced aperture

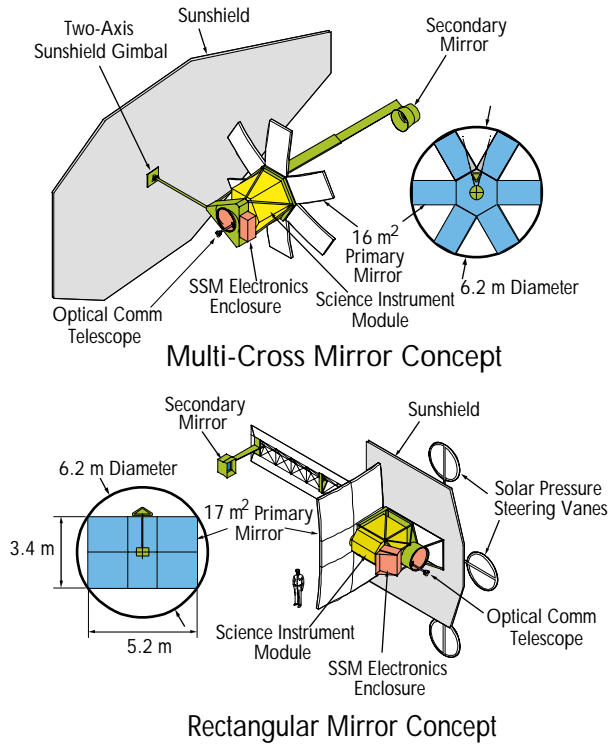

FIGURE D.1. NGST- δ Concepts. The reduced size and costs still provide core science with a Delta II class launch vehicle. (NASA/GSFC)

in finding acceptably bright guide stars. To simplify and reduce the volume of the optics within the SI Module, the deformable mirror is deleted in favor of performing active figure control at the primary mirror. The fast steering mirror is retained for line-of-sight jitter control.

By deleting the mid-infrared scientific capabilities, we can permit the mirror temperature to increase substantially without increasing the thermal background in the most sensitive region in the NIR (1–3 μm). A simpler, lower mass, two-layer sunshield is sufficient to allow the mirror to passively cool to $\sim 100\text{--}150$ K. The thermal isolation between the SSM and the SI Module/OTA is less demanding, and electrical harnesses can be shorter.

To further reduce mass, we adopt a highly integrated “sciencecraft” approach for the SSM. Through use of standardized card size, backplane, and bus architecture, a single avionics enclosure can house most SSM subsystems. Those SSM components that can not be standardized

in size, such as reaction wheels and batteries, mount to adjacent structural elements. Thermal isolation of the OTA and SI Module is achieved through use of high stiffness/low thermal conductivity (e.g., gamma-alumina) struts to support the OTA in combination with thermal radiation shielding.

Additional cost and mass reduction is achieved by incorporating the following changes with respect to the GSFC 8 m NGST concept:

- Deletion of the propulsion system through adoption of a solar drift-away orbit (Chapter 5),
- Using solar torque control to manage angular momentum by either warping and gimbaling the sunshield (multi-cross concept) or employing steerable solar vanes (rectangular aperture concept),
- Reduce communication mass and power through use of optical laser communications in place of an RF system for high-rate data transmission,
- Use of stored cryogenics (five year life) for detector cooling instead of a mechanical cryo-cooler, and
- Use of smaller reaction wheels and electrical power system.

ACRONYMS

ACS	Advanced Camera for Surveys
AGN	Active Galactic Nuclei
ARC	Ames Research Center
AU	Astronomical Unit
AURA	Association of Universities for Research in Astronomy
AXAF	Advanced X-ray Astrophysics Facility
BMDO	Ballistic Missile Defense Organization
CAN	Cooperative Agreement Notice
C&DH	Command and Data Handling
CCD	Charge-Coupled Device
CFRP	Carbon Fiber Reinforced Plastics
CGRO	Compton Gamma Ray Observatory
COBE	Cosmic Background Explorer
COTS	Commercial Off The Shelf
CVD	Carbon Vapor Deposition
DM	Deformable Mirror
DoD	Department of Defense
DRM	Design Reference Mission
DSN	Deep Space Network
EELV	Evolved Expendable Launch Vehicle
EPF	Extended Payload Fairing
ESA	European Space Agency
ESO	European Southern Observatory
EUVE	Extreme UltraViolet Explorer
ExNPS	Exploration of Neighboring Planetary Systems
FGS	Fine Guidance Sensor
FIRST	Far InfraRed Space Telescope
FOV	Field of View
FUSE	Far Ultraviolet Spectroscopic Explorer
GEO	Geosynchronous Earth Orbit
GSFC	Goddard Space Flight Center
HARD	High Accuracy Reflector Development

HDF	Hubble Deep Field
HEO	High Earth Orbit
HST	Hubble Space Telescope
IBC	Impurity Band Conduction
IMOS	Integrated Modeling of Optical Systems
IPT	Integrated Product Team
IRAS	Infrared Astronomy Satellite
ISM	Interstellar Medium
IR	Infrared
ISIS	Inflatable Shield in Space
ISO	Infrared Space Observatory
IUE	International Ultraviolet Explorer
JPL	Jet Propulsion Laboratory
L2	Second Lagrange Point
LaRC	Langley Research Center
LEO	Low Earth Orbit
MAP	Microwave Anisotropy Probe
MARS	Membrane with Active Rigid Support
MidEX	Mid-sized Explorer
MIR	Mid-Infrared
MIRORS	Mid-Infrared Optimized Resolution Spacecraft
MLI	Multi-Layer Insulation
MSFC	Marshall Space Flight Center
NAR	Non-Advocate Review
NAS	National Academy of Sciences
NASA	National Aeronautics and Space Administration
NEAR	Near Earth Asteroid Rendezvous
NGST	Next Generation Space Telescope
NICMOS	Near Infrared Camera Multi-Object Spectrometer
NRA	NASA Research Announcement
NIR	Near Infrared
NSF	National Science Foundation
OERB	Origins External Review Board
OPS	Operations
OSS	Office of Space Science
OTA	Optical Telescope Assembly
PAH	Polycyclic Aromatic Hydrocarbons

PNAR	Preliminary Non-Advocate Review
POIROT	Passively Cooled Orbiting Infrared Observatory Telescope
PSF	Point Spread Function
QE	Quantum Efficiency
RMS	Root Mean Square
RF	Radio Frequency
SDIO	Strategic Defense Initiative Organization
SI Module	Science Instrument Module
SIM	Space Interferometry Mission
SIRTF	Space Infrared Telescope Facility
SISWG	Space Interferometry Science Working Group
SOC	Science Oversight Committee
SOFIA	Stratospheric Observatory for Infrared Astronomy
SOHO	Solar and Heliospheric Observatory
SSB	Space Studies Board
SSM	Spacecraft Support Module
STScI	Space Telescope Science Institute
SWG	Science Working Group
TPF	Terrestrial Planet Finder
UV	Ultraviolet
VLA	Very Large Array
VLT	Very Large Telescope
VLTI	Very Large Telescope Interferometer
WFE	Wavefront Error
WFPC2	Wide Field Planetary Camera 2
XTE	X-ray Timing Explorer